



M30850T-EPB

Emulation Probe for M32C/80, 84, 85 and 86 Groups

User's Manual

* NQPACK, YQPACK, YQSOCKET, YQ-GUIDE, HQPACK, TQPACK and TQSOCKET are trademarks of Tokyo Eletech Corporation.

* IC61-1004-051 is a trademark of Yamaichi Electronics Co., Ltd.

Keep safety first in your circuit designs!

- Renesas Technology Corporation and Renesas Solutions Corporation put the maximum effort into making semiconductor products better and more reliable, but there is always the possibility that trouble may occur with them. Trouble with semiconductors may lead to personal injury, fire or property damage. Remember to give due consideration to safety when making your circuit designs, with appropriate measures such as (i) placement of substitutive, auxiliary circuits, (ii) use of nonflammable material or (iii) prevention against any malfunction or mishap.

Notes regarding these materials

- These materials are intended as a reference to assist our customers in the selection of the Renesas Technology product best suited to the customer's application; they do not convey any license under any intellectual property rights, or any other rights, belonging to Renesas Technology Corporation, Renesas Solutions Corporation or a third party.
- Renesas Technology Corporation and Renesas Solutions Corporation assume no responsibility for any damage, or infringement of any third-party's rights, originating in the use of any product data, diagrams, charts, programs, algorithms, or circuit application examples contained in these materials.
- All information contained in these materials, including product data, diagrams, charts, programs and algorithms represents information on products at the time of publication of these materials, and are subject to change by Renesas Technology Corporation and Renesas Solutions Corporation without notice due to product improvements or other reasons. It is therefore recommended that customers contact Renesas Technology Corporation, Renesas Solutions Corporation or an authorized Renesas Technology product distributor for the latest product information before purchasing a product listed herein. The information described here may contain technical inaccuracies or typographical errors. Renesas Technology Corporation and Renesas Solutions Corporation assume no responsibility for any damage, liability, or other loss rising from these inaccuracies or errors. Please also pay attention to information published by Renesas Technology Corporation and Renesas Solutions Corporation by various means, including the Renesas home page (<http://www.renesas.com>).
- When using any or all of the information contained in these materials, including product data, diagrams, charts, programs, and algorithms, please be sure to evaluate all information as a total system before making a final decision on the applicability of the information and products. Renesas Technology Corporation and Renesas Solutions Corporation assume no responsibility for any damage, liability or other loss resulting from the information contained herein.
- Renesas Technology semiconductors are not designed or manufactured for use in a device or system that is used under circumstances in which human life is potentially at stake. Please contact Renesas Technology Corporation, Renesas Solutions Corporation or an authorized Renesas Technology product distributor when considering the use of a product contained herein for any specific purposes, such as apparatus or systems for transportation, vehicular, medical, aerospace, nuclear, or undersea repeater use.
- The prior written approval of Renesas Technology Corporation and Renesas Solutions Corporation is necessary to reprint or reproduce in whole or in part these materials.
- If these products or technologies are subject to the Japanese export control restrictions, they must be exported under a license from the Japanese government and cannot be imported into a country other than the approved destination. Any diversion or reexport contrary to the export control laws and regulations of Japan and/or the country of destination is prohibited.
- Please contact Renesas Technology Corporation or Renesas Solutions Corporation for further details on these materials or the products contained therein.

Precautions to be taken when using this product

- This product is a development supporting unit for use in your program development and evaluation stages. In mass-producing your program you have finished developing, be sure to make a judgment on your own risk that it can be put to practical use by performing integration test, evaluation, or some experiment else.
- In no event shall Renesas Solutions Corporation be liable for any consequence arising from the use of this product.
- Renesas Solutions Corporation strives to renovate or provide a workaround for product malfunction at some charge or without charge. However, this does not necessarily mean that Renesas Solutions Corporation guarantees the renovation or the provision under any circumstances.
- This product has been developed by assuming its use for program development and evaluation in laboratories. Therefore, it does not fall under the application of Electrical Appliance and Material Safety Law and protection against electromagnetic interference when used in Japan.

For inquiries about the contents of this document or product, fill in the text file the installer of the emulator debugger generates in the following directory and email to your local distributor.

\\SUPPORT\Product-name\SUPPORT.TXT

Renesas Tools Homepage <http://www.renesas.com/en/tools>

Preface

The M30850T-EPB is an emulation probe for M32C/80, 84, 85 and 86 Groups MCUs. The M30850T-EPB is used by connecting to the PC7501 emulator main unit.

This user's manual mainly describes specifications of the M30850T-EPB emulation probe and how to setup it. For details on the following products, which are used with the M30850T-EPB, refer to each product's user's manual.

- Emulator: PC7501 User's Manual
- Emulator debugger: M3T-PD308F User's Manual

All the components of this product are shown in "2.2 Package components" (page 21). If there is any question or doubt about this product, contact your local distributor.

To use the product properly

Precautions for Safety:



- In both this user's manual and on the product itself, several icons are used to insure proper handling of this product and also to prevent injuries to you or other persons, or damage to your properties.
- The icons' graphic images and meanings are given in "Chapter 1. Precautions for Safety" (page 7). Be sure to read this chapter before using the product.

Contents

Chapter 1. Precautions for Safety	7
1.1 Safety Symbols and Meanings	9
Chapter 2. Preparation	19
2.1 Terminology	20
2.2 Package Components	21
2.3 Other Tool Products Required for Development	21
2.4 Name of Each Part	22
(1) System Configuration	22
(2) Names and Functions of the PC7501 Upper Panel LEDs	22
2.5 When Using the Emulator for the First Time	24
Chapter 3. Setting Up	25
3.1 Selecting Clock Supply	26
3.2 Using an Internal Oscillator Circuit Board	27
(1) Kinds of Oscillator Circuit Boards	27
(2) Replacing an Oscillator Circuit Board	27
(3) Using the Oscillator Circuit Bare Board	29
3.3 Using the Oscillator Circuit on the Target System	30
3.4 Using the Internal Oscillator Circuit	31
3.5 Setting Switches	31
3.6 A-D Conversion Bypass Capacitor	35
3.7 Connecting the PC7501	36
3.8 Connecting the Target System	37
(1) Connecting to a 100-pin LCC Socket	38
(2) Connecting to a 100-pin 0.65-mm-pitch Foot Pattern (Part 1)	39
(3) Connecting to a 100-pin 0.65-mm-pitch Foot Pattern (Part 2)	40
(4) Connecting to a 100-pin 0.65-mm-pitch Foot Pattern (Part 3)	41
(5) Connecting to a 100-pin 0.5-mm-pitch Foot Pattern (Part 1)	42
(6) Connecting to a 100-pin 0.5-mm-pitch Foot Pattern (Part 2)	43
(7) Connecting to a 100-pin 0.5-mm-pitch Foot Pattern (Part 3)	44
(8) Connecting to a 144-pin 0.5-mm-pitch Foot Pattern	45
Chapter 4. Usage	47
4.1 Turning On the Power	48
(1) Checking the Connection of the Emulator System	48
(2) Turning ON/OFF the Power	48
(3) LED Display When the Emulator Starts Up Normally	49

4.2 Downloading Firmware	50
(1) When It is Necessary to Download Firmware	50
(2) Downloading Firmware in Maintenance Mode	50
4.3 Starting Up the Emulator Debugger (Setting the EMEM Dialog Box)	51
(1) Setting the Debug Monitor Bank Address	52
(2) Selecting a Processor Mode	52
(3) Setting Emulation Memory	53
(4) Emulation Memory Allocation as Expansion Area	53
(5) Referring MCU STATUS	55
4.4 Self-check	55
(1) Self-check Procedure	55
(2) If an Error is Detected in the Self-check	55
Chapter 5. Specifications	57
5.1 Specifications	58
5.2 Connection Diagrams	59
5.3 External Dimensions	61
(1) External Dimensions of the Emulation Probe	61
(2) External Dimensions of Converter Board M30800T-PTC	62
(3) External Dimensions of Converter Board M3T-F160-100NSD	63
(4) External Dimensions of Converter Board M3T-FLX-144NSD	63
Chapter 6. Troubleshooting	65
6.1 Flowchart to Remedy the Troubles	66
6.2 When the Emulator Debugger Does Not Start Up Properly	67
(1) When the LED Display of the PC7501 is Abnormal	67
(2) EMEM Dialog Box is Not Displayed at Debugger Startup (Target Connected)	68
(3) EMEM Dialog Box is Not Displayed at Debugger Startup (Target Not Connected)	69
(4) Errors Occur at Debugger Startup (Target Connected).....	69
6.3 How to Request for Support	70
Chapter 7. Maintenance and Guarantee	71
7.1 Maintenance	72
7.2 Guarantee	72
7.3 Repair Provisions	72
7.4 How to Request for Repair	73

MEMO

Chapter 1. Precautions for Safety

This chapter describes precautions for using this product safely and properly. For precautions for the emulator main unit and the emulator debugger, refer to each user's manual included with your product.

1.1 Safety Symbols and Meanings	9
WARNING Warning for Handling This Product	10
Warning for Installation	10
Warning for Use Environment	10
CAUTION Cautions for Powering On	10
Cautions to Be Taken for Handling This Product	10
Caution to Be Taken for Malfunctions	10
IMPORTANT Notes on Downloading Firmware	11
Note on Quitting the Emulator Debugger	11
Note on Differences between an Actual MCU and the Emulator	11
Notes on Target System	12
Notes on Using This Product When the Voltage of VCC1 is Higher than That of VCC2	12
Note on RESET* Input	12
Note on RDY* Input	12
Note on HOLD* Input	12
Note on NMI* Interrupt	12
Notes on Clock Supply to an MCU	13
Notes on Using the CPU Clock at Less than 16 MHz	13
Notes on EMEM Dialog Box	14
Notes on Address-Match Interrupt	15
Notes on Watchdog Function	15
Notes on Debugging in CPU Rewrite Mode	15
Notes on Reset Vector Area	15
Notes on Stack Area	16
Notes on Interrupts	16
Note on Software Break	16
Notes on Access Prohibited Area	16
Note on DMA Transfer	17
Note on DMAC II Transfer Completion Interrupts	17



Note on Downloading Programs	17
Notes on Service-Life of the MCU's Internal Flash ROM	17
Note on Voltage Detect Circuit	17
Notes on A-D Conversion	18
Note on Protect Resistor	18
Note on Applicable MCUs	18
Note on Final Evaluation	18

Chapter 1. Precautions for Safety

In both the user's manual and on the product itself, several icons are used to insure proper handling of this product and also to prevent injuries to you or other persons, or damage to your properties.

This chapter describes the precautions which should be taken in order to use this product safely and properly. Be sure to read this chapter before using this product.

1.1 Safety Symbols and Meanings

	WARNING	If the requirements shown in the "WARNING" sentences are ignored, the equipment may cause serious personal injury or death.
	CAUTION	If the requirements shown in the "CAUTION" sentences are ignored, the equipment may malfunction.
	IMPORTANT	It means important information on using this product.

In addition to the three above, the following are also used as appropriate.

△ means WARNING or CAUTION.
Example:  **CAUTION AGAINST AN ELECTRIC SHOCK**

⊘ means PROHIBITION.
Example:  **DISASSEMBLY PROHIBITED**

● means A FORCIBLE ACTION.
Example:  **UNPLUG THE POWER CABLE FROM THE RECEPTACLE.**

The following pages describe the symbols "WARNING", "CAUTION", and "IMPORTANT".

WARNING

Warning for Handling This Product:



- Do not disassemble or modify this product. Disassembling or modifying this product can cause damage.

Warning for Installation:



- Do not set this product in water or areas of high humidity. Spilling water or some other liquid into the main unit can cause an unreparable damage.

Warning for Use Environment:



- This equipment is to be used in an environment with a maximum ambient temperature of 35°C. Care should be taken that this temperature is not exceeded.

CAUTION

Cautions for Powering On:



- Turn ON the power of the emulator and target system as simultaneously as possible.
- Turn OFF the power of the emulator and target system as simultaneously as possible.
- Do not leave either the emulator or target system powered on, because of leakage current the internal circuits may be damaged.
- When turning ON the power again after shutting OFF the power, wait about 10 seconds.

Cautions to Be Taken for Handling This Product:



- Use caution when handling the main unit. Be careful not to apply a mechanical shock.
- Do not touch the connector pins of the emulator main unit and the target MCU connector pins. Static electricity may damage the internal circuits.
- Do not pull this product by the flexible cable for connecting to the emulator main unit and emulation probe. The cable may cause a break.
- Do not flex the flexible cable for connecting to the emulator main unit and emulation probe excessively. The cable may cause a break.
- Do not use inch-size screws for this equipment. The screws used in this equipment are all ISO (meter-size) type screws. When replacing screws, use same type screws as equipped before.

Caution to Be Taken for Malfunctions:



- If the emulator malfunctions because of interference like external noise, do the following to remedy the trouble.
 - (1) Press the RESET switch on the emulator upper panel.
 - (2) If normal operation is not restored after step (1), shut OFF power to the emulator once and then reactivate it.

IMPORTANT

Notes on Downloading Firmware:

- Before using this product for the first time, it is necessary to download the dedicated firmware (control software built into the PC7501). Please note that, to do this, it is necessary to start up the PC7501 in maintenance mode. For firmware download procedures, see "4.2 Downloading Firmware" (page 50). Once the firmware has been downloaded, the product can be used by simply turning on the power.
- Do not shut off the power while downloading the firmware. If this happens, the product will not start up properly. If power is shut off unexpectedly, redownload the firmware.
- Except when a target status error occurs, if the self-check is not completed successfully, there may be trouble with the product. In such case, contact your sales representative. However, perform the self-check while not connecting the target system.

Note on Quitting the Emulator Debugger:

- To restart the emulator debugger after it ends, always shut power to the emulator module off once and then on again.

Note on Differences between an Actual MCU and the Emulator:

- Operations of the emulator differs from those of mask MCUs as listed below.

- (1) Reset conditions
- (2) Initial values of internal resource data at power-on
- (3) Interrupt stack pointer (ISP) after releasing reset
- (4) Internal memories (ROM and RAM) capacities, etc.

This emulator system has an MCU with 24KB RAM (400h--63FFh). In single-chip mode or memory expansion mode, internal flash memory is automatically allocated in F000h--FFFFh and F80000h--FFFFFFh, and it can be accessed.

- (5) Oscillator circuit

- Make note of the fact that in the oscillator circuit where a resonator is connected between pins X_{IN} and X_{OUT}, oscillation does not occur because a converter board and other devices are used between the evaluation MCU and the target system. It is same for a sub-clock oscillator (X_{CIN} and X_{COUT}).
- For notes on when using the oscillator circuit on the target system, refer to "3.3 Using the Oscillator Circuit on the Target System" (page 30).

- (6) A-D conversion

As a converter board and other devices are used between the evaluation MCU and the target system, some characteristics are slightly different from those of an actual MCU.

- (7) Port P15

As one of I/O ports (P15) is connected to the target system through the analog switch circuit, electric characteristics slightly differ from those of an actual MCU.

- (8) When the SW4 is set to XOUT in stop mode, a clock is output from the XOUT pin.

IMPORTANT

Notes on Target System:

- Pin Vcc of the emulator is connected to the target system to observe the voltage of the target system. Therefore design your system so that the emulator MCU is powered by the target system.
- The voltage of the target system should be within the following.
 - (1) When JP1 is set as VCC1 = 2:
 $3.0\text{ V} \leq \text{VCC1} = \text{VCC2} \leq 5.5\text{ V}$
 - (2) When JP1 is set as VCC1 > 2:
 $4.8\text{ V} \leq \text{VCC1} \leq 5.2\text{ V}$
 $3.3\text{ V} \leq \text{VCC2} < \text{VCC1}$

Do not change the voltage of the target system after turning on the power.

Notes on Using This Product When the Voltage of VCC1 is Higher than That of VCC2:

- If using this product when the voltage of VCC1 is higher than that of VCC2, set the JP1 to VCC1>2. For the switch JP1, refer to "3.5 Setting Switches" (page 31).
- When the JP1 is set to VCC1>2, the voltage of VCC2 on the target system should be 3.3 V or more.
- If using a CPU clock of 30 MHz or more when the voltage of VCC1 is higher than that of VCC2, set the SFR area of the intelligent I/O function to 2-wait (set the PM13 bit to "1") when reading this area. This precaution only needs to be observed when using an emulator, and does not apply for the actual MCU.

Note on RESET* Input:

- The RESET* input from the target system is accepted only while a user program is being executed (only while the RUN status LED on the PC7501's upper panel is lit).

Note on RDY* Input:

- Be sure to input "L" to pin RDY* of the target system during the user program executing (only while the RUN status LED on the PC7501's upper panel is lit). Inputting "L" to pin RDY* during the user program stopping may cause a malfunction of the emulator.

Note on HOLD* Input:

- Be sure to input "L" to pin HOLD* of the target system during the user program executing (only while the RUN status LED on the PC7501's upper panel is lit). Inputting "L" to pin HOLD* during the user program stopping may cause a malfunction of the emulator.

Note on NMI* Interrupt:

- NMI* input from the target system is accepted only while a user program is being executed (only while the RUN status LED on the PC7501's upper panel is lit).

IMPORTANT

Notes on Clock Supply to an MCU:

- Clock can be supplied to the evaluation MCU in one of the following three ways. This is determined by emulator debugger clock selection.
 - (1) When Internal is selected:

The clock generated by the oscillation circuit in the PC7501 is supplied to the evaluation MCU. The clock is continually supplied to the evaluation MCU regardless of "target system clock status" and "user program execution status".
 - (2) When External is selected:

Clock supply to the evaluation MCU depends on oscillation status (oscillate/off) of the target system.
 - (3) When Generate is selected:

A clock generated by the dedicated circuit in the PC7501 is supplied to the evaluation MCU. The clock is continually supplied to the evaluation MCU regardless of "target system clock status" and "user program execution status".
- When operating this product with XCIN, be sure to set the SW2 and SW3 to XCIN and NC, respectively.

Notes on Using the CPU Clock at Less than 16 MHz:

- To use the CPU clock at less than 16 MHz, execute the command shown below in the Script Window after starting the emulator debugger M3T-PD308F.

```
[Command]
_settimeout 300
```

Once this command is executed, it remains effective the next time you start the emulator debugger M3T-PD308F. Therefore, you do not need to execute this command again.
- When you use the CPU clock at less than 1 MHz, contact your local distributor.

IMPORTANT

Notes on EMEM Dialog Box:

Observe the following when setting up EMEM dialog box of the emulator debugger.

(1) Debug Monitor Bank Address

- When "F0" is specified, 64 KB of area starting from F00000h are allocated for use by the debug monitor.
- The 64 KB allocated for the debug monitor cannot be used.
- The below areas cannot be set for the debug monitor.

(1) MCU internal resources (ROM/RAM/SFR area)

(2) Multiplex area

(3) Interrupt vector area

- It is not possible to view or set the content of the specified area. Even on the memory window or in the reverse assemble area of the program/source windows, the content of this area is not displayed correctly though it can be displayed.

(2) Processor Mode

- Set a processor mode for the target MCU.
- To set single-chip mode or memory expansion mode, pin CNVSS used with MCU status must be "L". MCU status indicates pin level of the target system.
- To set microprocessor mode, pin CNVSS used with MCU status must be "H".
- To set memory expansion mode or microprocessor mode, pins RDY* and HOLD* used with MCU status must be "H".
- When the target system is not connected, all modes are available.

(3) Emulation Memory Allocation

- The 4MB memory mounted in the PC7501 can be allocated out.
- When single-chip mode or memory expansion mode is set as a processor mode, ROM area is automatically allocated to the internal Flash ROM of an MCU. Therefore, it is not necessary to deliberately specify the emulation memory as expansion area in order to allocate the ROM area.
- Except for the SFR, RAM, ROM and internally reserved areas, all areas other than the set area are externally accessible.
- MCU internal resources are automatically selected for SFR, RAM and ROM areas regardless of settings.
- Be careful that the specified areas do not overlap one another.
- Set memory allocation so that the total of the 4 length values does not exceed the emulation memory size (4 MB).
- Do not set a multiplex bus area and unusable areas for memory allocation.
- Emulator main unit's memory is automatically selected as a reset vector area regardless of settings.

IMPORTANT

Notes on Address-Match Interrupt:

- Do not single-step an address where an address-match interrupt occurs.
- When using an address-match interrupt, do not check the box of "Enable the Address Match Interrupt Break Function" in the MCU tab of the Init dialog box. When not using an address-match interrupt, check the box.
- When you use address-match breaks, if a low reset is input during a user program execution, a debug monitor program (about 100 cycles) is executed after a reset is released. Take note that it has effects on the user program execution time and the result of a trace.

Notes on Watchdog Function:

- When using the watchdog function, check the box of "Debug the program using the watchdog timer" in the MCU tab of the Init dialog box.
- When not using the watchdog function, do not check the box.
- If the reset circuit of the target system has a watchdog timer, disable it when using the emulator.

Notes on Debugging in CPU Rewrite Mode:

- To debug a program in CPU rewrite mode, check the box "Debug the program using the CPU Rewrite Mode" in the MCU tab of the Init dialog box.
- When you do not debug a program in CPU rewrite mode, uncheck the box.
- When you debug a program in CPU rewrite mode, the block 0 area (FFF000h--FFFFFFh) must not be rewritten. Otherwise, the emulator will be out of control.
- When debugging in CPU rewrite mode is enabled, you cannot use the following functions.
 - (1) Setting an address match breakpoint
 - (2) Setting a software breakpoint to the internal ROM area
 - (3) Executing COME to the internal ROM area
- Do not use the following functions to the rewrite control program area (from setting CPU rewrite mode select bit to releasing it). If any of these are used, malfunctions may occur (e.g. The emulator cannot shift to CPU rewrite mode or contents of ROM cannot be read out properly.).
 - (1) Single stepping
 - (2) Setting a software breakpoint
 - (3) Setting a hardware breakpoint
 - (4) Executing COME

Notes on Reset Vector Area:

- For a reset vector area, memory of the emulator is always selected regardless of the setting of the EMEM dialog box. Therefore when setting a microprocessor mode, to use a ROM of the target system etc. as an area including a reset vector area, set a reset vector using a memory window etc.
- A reset vector area can be changed only when a program is stopped. When a program is executed, the area can not be changed.

IMPORTANT

Notes on Stack Area:

- With this product, a maximum 20 bytes of the user stack is consumed as a work area.
- If the user stack does not have enough area, do not use areas which cannot be used as stack (SFR area, RAM area which stores data, or ROM area) as work area. Using areas like this is a cause of user program crashes and destabilized emulator control. Therefore, ensure the +20 byte maximum capacity used by the user program as the user stack area.
- With this product, the interrupt stack pointer (ISP) is set to 0500h and used as stack area after the reset is released.

Notes on Interrupts:

- Even if a user program is not being executed (when the user program is stopped or when run-time debugging is being performed), the evaluation MCU keeps running so as to control the emulation probe. Therefore, timers and other components do not stop running.
- When the user program is not being executed (when the user program is paused or when run-time debugging is being performed), a peripheral I/O interrupt is not accepted. Take note that when the user program is not being executed, a peripheral I/O interrupt request can be cleared.

Note on Software Break:

- A software break generates a break interruption by forcibly inserting a BRK instruction "08h" instead of an instruction code. Therefore, when referencing the result of a trace in bus mode, "08h" is displayed for the instruction fetch address where a software break is set.

Notes on Access Prohibited Area:

- The emulator control register (000020h--00003Fh) in the SFR is read- and write-protected. When this register is accessed, emulator control cannot be utilized.
- With this product, address FFFFFFFh cannot be read or written in correctly.

IMPORTANT

Note on DMA Transfer:

- With this product, the user program is stopped with a loop program to a specific address. Therefore, if a DMA request is generated by a timer or other source while the user program is stopped, DMA transfer is executed. However, make note of the fact that DMA transfer while the program is stopped may not be performed correctly. Also note that the below registers have been changed to generate DMA transfer as explained here even when the user program is stopped.

DMA0 transfer count register DCT0
DMA1 transfer count register DCT1
DMA0 memory address register DMA0
DMA1 memory address register DMA1
DMA2 transfer count register DCT2 (R0)
DMA3 transfer count register DCT3 (R1)
DMA2 memory address register DMA2 (A0)
DMA3 memory address register DMA3 (A1)

Note on DMAC II Transfer Completion Interrupts:

- You can use DMAC II transfer completion interrupts during program execution only. Do not generate DMAC II transfer completion interrupts when you use any function but program execution.

Note on Downloading Programs:

- When you download a program to an internal ROM area and set software breaks, the main clock operates in divide-by-8 mode. Keep it in mind when you specify a watchdog timer refresh interval.

Notes on Service-Life of the MCU's Internal Flash ROM:

- With the M30850T-EPB, programs are downloaded to the MCU's flash ROM when debugging in single-chip mode or memory expansion mode. Because the number of write/erase cycles of this ROM is limited, the ROM must be replaced when at the end of its service-life.
- If the following errors occur frequently during program download, replace the emulation probe or request for repair.

Flash ROM erase error occurred ERROR (16258)
Flash ROM verify error occurred ERROR (16259)

To purchase the product for replacement or request for repair, contact your local distributor.

Note on Voltage Detect Circuit:

- As the power voltage cannot be changed after powering on the target system, the voltage detect circuit (voltage down detect interrupt and hardware reset 2) cannot be used with this product.

IMPORTANT

Notes on A-D Conversion:

- When setting the register below to use the analog input port selection function, you need to set the direction register of port P15 for a pin that performs A-D conversion to "input". And you need to set the function selection register of port P15 for a pin that performs A-D conversion to "I/O port".

A-D0 control register 2 (address 394h)

b2, b1

1, 0 : AN00 to AN07

1, 0 : AN20 to AN27

Also, when the P0 group and P2 group are selected for A-D input, port P15 cannot be used as an I/O port. When setting the register above, port P15 cannot be used as an I/O port even if A-D conversion is halting.

For the switch SW5, refer to "3.5 Setting Switches" (page 31).

- When setting the register below to use multi-port sweep mode, you need to set the direction register of port P15 for a pin that performs A-D conversion to "input". And you need to set the function selection register of port P15 for a pin that performs A-D conversion to "I/O port".

A-D0 control register 4 (address 392h)

b3, b2

1, 0 : AN0 to AN7, AN00 to AN07

1, 0 : AN0 to AN7, AN20 to AN27

Also, when the P0 group and P2 group are used for multi-port sweep mode, port P15 cannot be used as an I/O port. When setting the register above, port P15 cannot be used as an I/O port even if A-D conversion is halting.

- Because a converter board and other devices are used between the evaluation MCU and the target system, the A-D converter operates differently from an actual MCU. Make the final evaluation of the A-D converter using an actual MCU.

Note on Protect Resistor:

- A protect is not canceled when protect register bit 2 (PRC2), which enables writing in the port P9 direction register and the function select register A3, is changed with the below procedure.

(1) Step execution of an instruction setting ("1") PRC2

(2) Setting a break point from an instruction setting ("1") PRC2 to where the port P9 direction register or the function select register A3 is set

(3) Setting ("1") PRC2 from the dump window or script window during user program execution

Note on Applicable MCUs:

- The M30850T-EPB supports M32C/80, 84, 85 and 85 Group MCUs. As the ROM and RAM sizes and peripheral functions depend on a target MCU, refer to each hardware manual of the MCU to develop your system.

Note on Final Evaluation:

- Be sure to evaluate your system with an MCU for evaluation purposes. Before starting mask production, evaluate your system and make final confirmation with a CS (Commercial Sample) version MCU.

Chapter 2. Preparation

This chapter describes the package components, the system configuration and the preparation for using this product for the first time.

2.1 Terminology	20
2.2 Package Components	21
2.3 Other Tool Products Required for Development	21
2.4 Name of Each Part	22
(1) System Configuration	22
(2) Names and Functions of the PC7501 Upper Panel LEDs	22
2.5 When Using the Emulator for the First Time	24

Chapter 2. Preparation

2.1 Terminology

Some specific words used in this user's manual are defined as follows:

Emulator system

This means an emulator system built around the PC7501 emulator. The PC7501 emulator system is configured with an emulator main unit, emulation probe, host machine and emulator debugger.

Emulator main unit (Hereafter PC7501)

This means an emulator main unit for M16C Family MCUs.

Emulation probe

This means the emulation probe (this product) for the M32C/80, 84, 85 and 86 Group MCUs.

Host machine

This means a personal computer used to control the emulator main unit and emulation probe.

Emulator debugger

This means a software tool M3T-PD308F V.3.20 Release 1 or later to control the emulator from a host machine through an interface.

Firmware

Program that analyzes contents of communication with the emulator debugger and controls the emulator hardware. This program is installed in the flash memory in the emulator main unit. This program is downloadable from the emulator debugger to upgrade the firmware or to support other MCUs.

Software break

A software break is a function to break the program before the system executes an instruction at the specified address. The instruction at the preset address will not be executed.

Hardware break

A hardware break is a function to break the program when the system detects a write/read of data to/from memory or a leading/trailing edge of the signal entered from the external trace cable. The former break function is called address break; and the latter break function is called trigger break. While the instruction at the address where the software break is set is not executed, a hardware break is performed after the specified instruction is executed.

Evaluation MCU

This means the MCU mounted on the emulation probe which is operated in the specific mode for tools.

Target MCU

This means the MCU you are going to debug.

Target program

This means the program you are going to debug.

Target system

This means a user's application system using the microcomputer to be debugged.

*

In this user's manual, this symbol is used to show active Low. (e.g. RESET*: Reset signal)

2.2 Package Components

The M30850T-EPB package consists of the following items. When unpacking, check to see if your M30850T-EPB contains all of these items.

Table 2.1 Package components

Item	Quantity
M30850T-EPB emulation probe	1
M30800T-PTC converter board for 100-pin LCC	1
IC61-1004-051 100-pin LCC socket made by Yamaichi Electronics Co., Ltd.	1
OSC-3 (32 MHz) oscillator circuit board	1
OSC-2 oscillator circuit board (bare board)	1
Hardware tool user registration FAX sheet (English)	1
Hardware tool user registration FAX sheet (Japanese)	1
M30850T-EPB user's manual (this manual)	1
M30850T-EPB user's manual (Japanese)	1

* Please keep the M30850T-EPB's packing box and cushion material in your place for reuse at a later time when sending your product for repair or other purposes. Always use these packing box and cushion material when transporting this product.

* If there is any question or doubt about the packaged product, contact your local distributor.

* For purchasing the IC61-1004-051 or for technical information, contact Yamaichi Electronics Co., Ltd.

<http://www.yamaichi.co.jp/e/index.shtml>

2.3 Other Tool Products Required for Development

To bring forward programs development on the M32C/80, 84, 85 and 86 Group MCUs, the products listed below are necessary in addition to those contained package above. Get them separately.

Table 2.2 Other tool products required for development

Product	Product name	Notes
Emulator main unit	PC7501	Required
Emulator debugger	M3T-PD308F V.3.20 Release 1 or later	Required
Converter board	144-pin 0.5-mm-pitch LQFP (144P6Q-A)	M3T-FLX-144NSD
	100-pin 0.5-mm-pitch LQFP (100P6Q-A)	M3T-100LCC-QSD
		M3T-100LCC-DMS + M3T-FLX-100NSD
		M3T-F160-100NSD
	100-pin 0.65-mm-pitch QFP (100P6S-A)	M3T-100LCC-DMS + M3T-DUMMY100S
		M3T-100LCC-DMS + M3T-DIRECT100S
M3T-100LCC-DMS + M3T-FLX-100NRB		

* To purchase these products, contact your local distributor.

2.4 Name of Each Part

(1) System Configuration

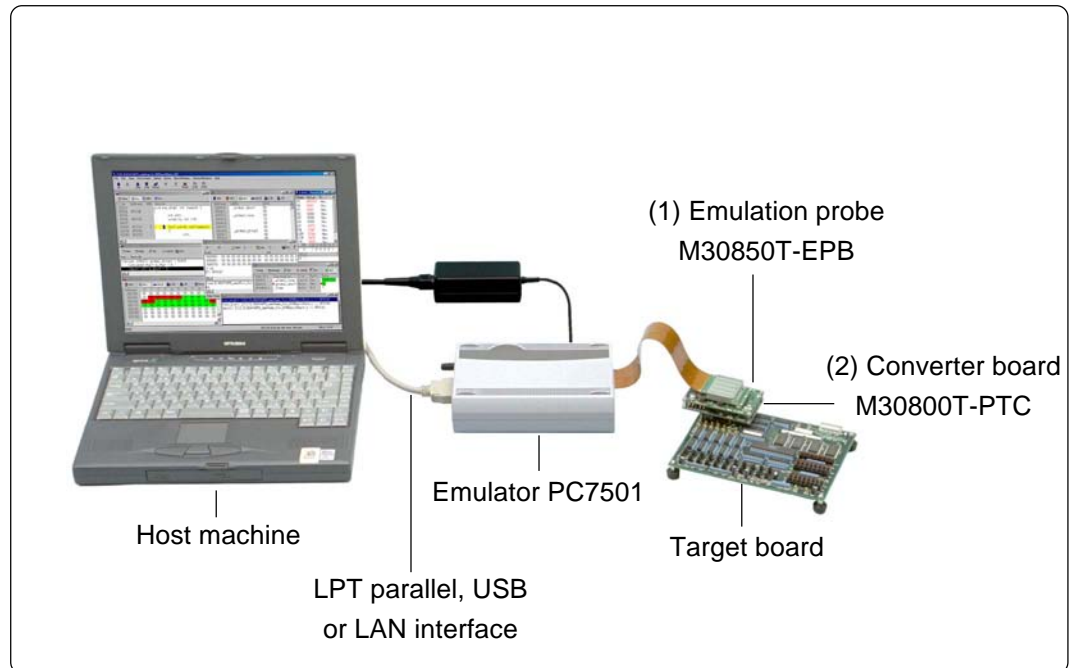

Figure 2.1 System configuration

- Emulation probe M30850T-EPB

This emulation probe contains an evaluation MCU.

- Converter board M30800T-PTC

This is a converter board for connecting to the target system (for 100-pin 0.65-mm-pitch LCC socket). For details, refer to "3.8 Connecting the Target System" (page 37)

(2) Names and Functions of the PC7501 Upper Panel LEDs

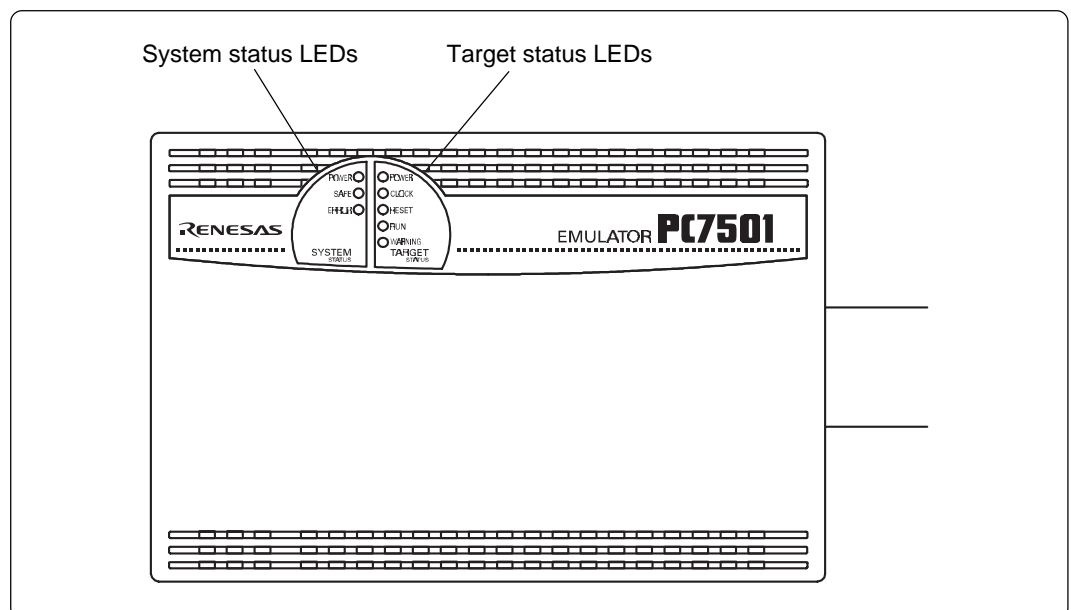

Figure 2.2 Names of PC7501 upper panel LEDs

(1) System Status LEDs

The system status LEDs indicate the emulator PC7501's power supply, firmware operating status, etc. Table 2.3 lists the definition of each system status LED.

Table 2.3 Definition of the system status LEDs

Name	Status	Meaning
POWER	ON	Emulator system power supply is turned ON.
	OFF	Emulator system power supply is turned OFF.
SAFE	ON	Emulator system is operating normally.
	Flashing	Special mode (maintenance mode) for downloading firmware. The emulator system does not operate except for downloading firmware and the self-check.
	OFF	Emulator system is not operating normally.
ERROR	ON	Emulator is not operating normally.
	Flashing	Downloading firmware
	OFF	Emulator is operating normally.

(2) Target Status LEDs

The target status LEDs indicate the target MCU's operating status and target board's power supply. Table 2.4 lists the definition of each target status LED.

Table 2.4 Definition of the target status LEDs

Name	Status	Meaning
POWER	ON	Power is supplied to the target board.
	OFF	Power is not supplied to the target board.
CLOCK	ON	Target MCU clock is oscillating.
	OFF	Target MCU clock is not oscillating.
RESET	ON	Target MCU is being reset.
	OFF	Target MCU is not being reset.
RUN	ON	Target program is being executed.
	OFF	Target program has been halted.
WARNING	ON	Target MCU internal clock is not oscillating.
	OFF	Target MCU internal clock is oscillating.

CAUTION

Caution for Target Status POWER LED:

- If your MCU has two or more power supply terminals (VCC), you need to supply power to all the terminals.

2.5 When Using the Emulator for the First Time

If you have purchased this emulation probe newly, it is necessary to download the firmware. The download procedure is given in Figure 2.3.

Before downloading the firmware, check the emulator debugger is installed and the PC7501 is connected to the host machine. For more information, see each user's manual of the emulator debugger and the PC7501.

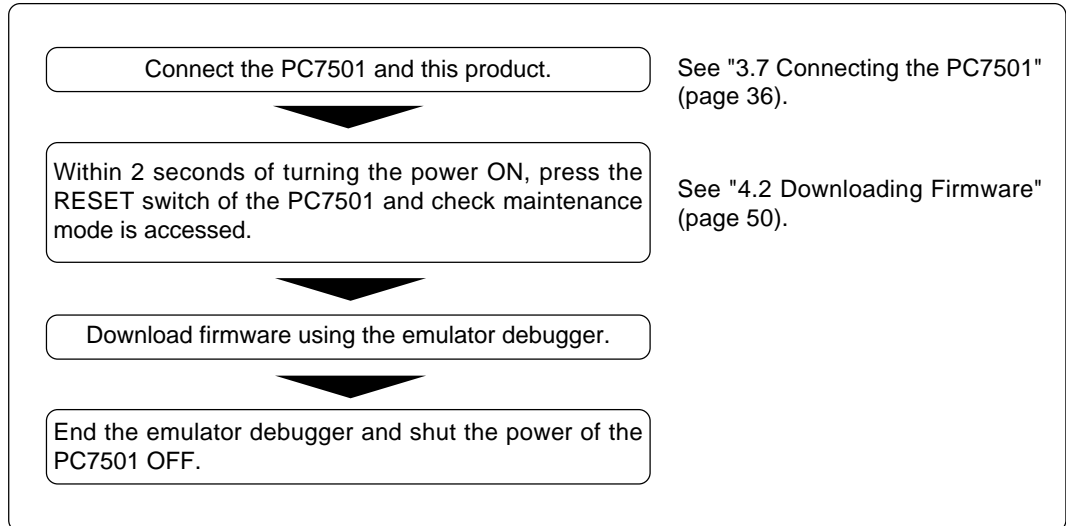

Figure 2.3 Firmware download procedure when the emulator is used for the first time

To make sure the emulation probe works properly, run the self-check. For the self-check procedures, see "4.4 Self-check" (page 55).

Chapter 3. Setting Up

This chapter describes switch settings required for using this product and how to connect this product to the PC7501 and the target system.

3.1 Selecting Clock Supply	26
3.2 Using an Internal Oscillator Circuit Board	27
(1) Kinds of Oscillator Circuit Boards	27
(2) Replacing an Oscillator Circuit Board	27
(3) Using the Oscillator Circuit Bare Board	29
3.3 Using the Oscillator Circuit on the Target System	30
3.4 Using the Internal Oscillator Circuit	31
3.5 Setting Switches	31
3.6 A-D Conversion Bypass Capacitor	35
3.7 Connecting the PC7501	36
3.8 Connecting the Target System	37
(1) Connecting to a 100-pin LCC Socket	38
(2) Connecting to a 100-pin 0.65-mm-pitch Foot Pattern (Part 1)	39
(3) Connecting to a 100-pin 0.65-mm-pitch Foot Pattern (Part 2)	40
(4) Connecting to a 100-pin 0.65-mm-pitch Foot Pattern (Part 3)	41
(5) Connecting to a 100-pin 0.5-mm-pitch Foot Pattern (Part 1)	42
(6) Connecting to a 100-pin 0.5-mm-pitch Foot Pattern (Part 2)	43
(7) Connecting to a 100-pin 0.5-mm-pitch Foot Pattern (Part 3)	44
(8) Connecting to a 144-pin 0.5-mm-pitch Foot Pattern	45

Chapter 3. Setting Up

3.1 Selecting Clock Supply

There are two ways to supply a clock to the MCU, using the oscillator circuit of the emulator or using the oscillator circuit on the target system. Table 3.1 lists the factory-settings of each clock supply.

Table 3.1 Clock supply to the MCU

Clock	Display of emulator debugger	Description	Default setting
Main X _{IN} -X _{OUT}	Internal	Internal oscillator circuit (OSC-3)	Yes
	External	Oscillator of target system	-
	Generate	Internal generator circuit (1.0 to 32.0 MHz)	-
Sub X _{CIN} -X _{COUT}	Internal	Internal oscillator circuit of emulator (32.768 kHz)	-
	External	Target system	Yes

IMPORTANT

Notes on Changing the Clock Supply:

- The clock supply can be set by the Init dialog box when starting up the emulator debugger or inputting CLK command on the script window.
- For X_{CIN}-X_{COUT}, it is necessary to set switches in the emulator. For details, refer to "3.5 Setting Switches" (page 31).

3.2 Using an Internal Oscillator Circuit Board

(1) Kinds of Oscillator Circuit Boards

The PC7501 comes with an oscillator circuit board OSC-3 (30 MHz). And an oscillator circuit board OSC-3 (32 MHz) is included with this product. If you use the internal oscillator circuit board of the PC7501 as a main clock, choose "Internal" in the emulator debugger after replacing oscillator circuit boards to change a clock supplied to an MCU.

(2) Replacing an Oscillator Circuit Board

1. Remove the four screws of both sides of this product and lift off the upper cover (see Figure 3.1).

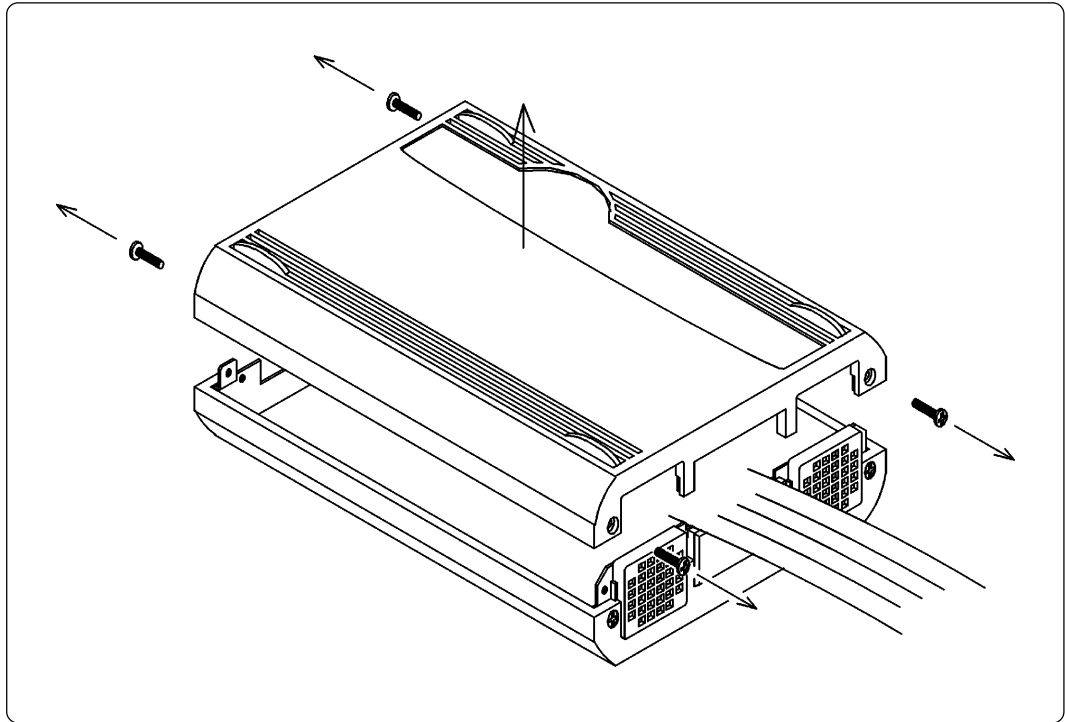

Figure 3.1 Removing the upper cover

2. Unscrew the screw of the oscillator circuit board of the PC7501 and replace it (see Figure 3.2).

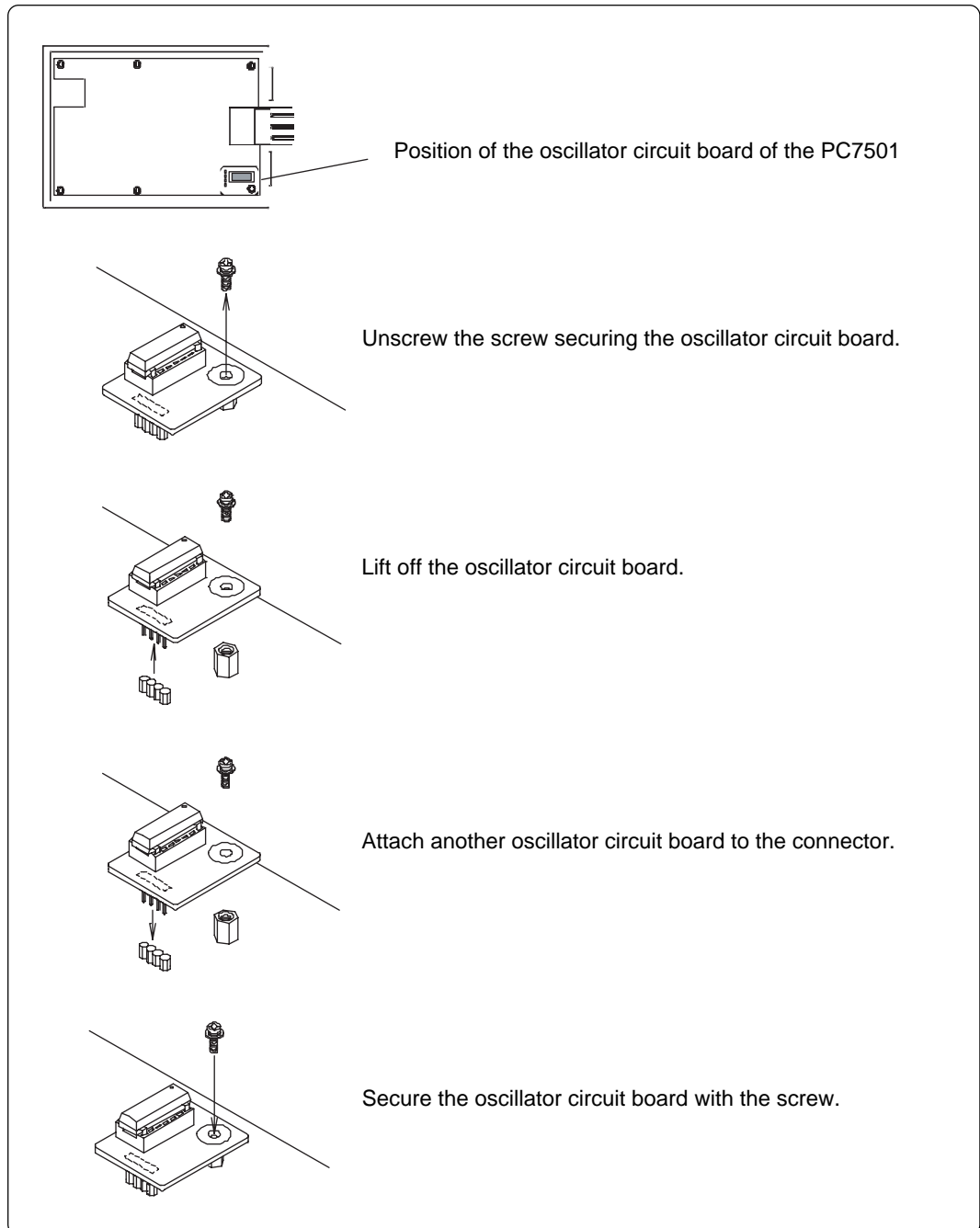

Figure 3.2 Replacing oscillator circuit boards

3. Reinstall the upper cover once removed and secure the four screws of the PC7501.

CAUTION

When Removing the Upper Cover:

- Always shut OFF power when removing the upper cover or changing the input frequency.

3.3 Using the Oscillator Circuit on the Target System

To operate this product with an oscillator circuit of the target system, input the oscillator output at 50% duty (within the operating range of the evaluation MCU) into pin X_{IN} as shown in Figure 3.5. Pin X_{OUT} should be open. Choose "External" in the emulator debugger to use this clock.

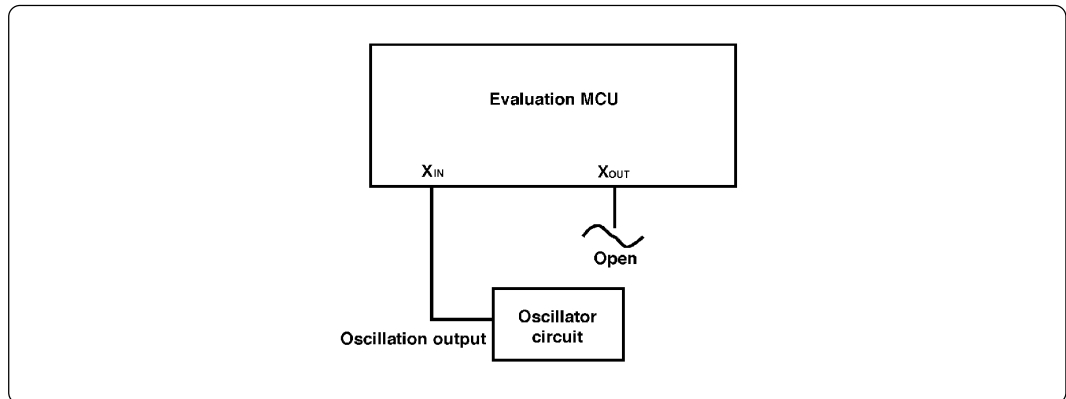

Figure 3.5 External oscillator circuit

In the oscillator circuit shown in Figure 3.6 where a resonator is connected between pins X_{IN} and X_{OUT} , oscillation does not occur because a converter board is used between the evaluation MCU and the target system.

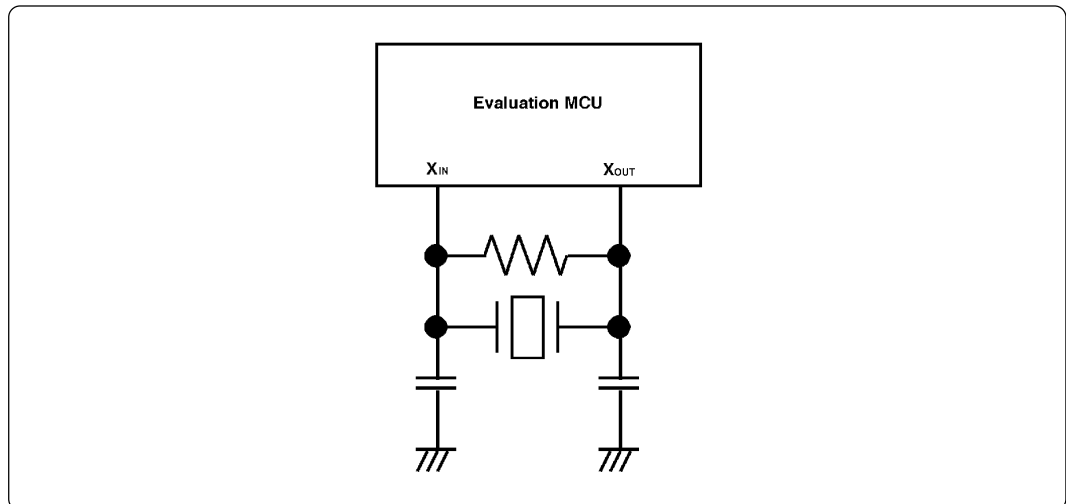

Figure 3.6 Circuit in which oscillation does not occur (same for X_{CIN} and X_{COUT})

IMPORTANT

Notes on External Clock:

- To operate this product with an external clock, construct the oscillator circuit as shown in Figure 3.5 in the target system and input the oscillator output at 50% duty (within the operating range of the evaluation MCU) into pin X_{IN} . And pin X_{OUT} should be open.
- Make note of the fact that in the oscillator circuit shown in Figure 3.6 where a resonator is connected between pins X_{IN} and X_{OUT} , oscillation does not occur because a converter board and other devices are used between the evaluation MCU and the target system. It is same for sub-clock oscillator circuits (X_{CIN} and X_{COUT}).

3.4 Using the Internal Oscillator Circuit

The dedicated circuit in the PC7501 can generate any arbitrary frequency specified by the emulator debugger, and it is supplied as a main clock. It does not depend on either the oscillator circuit board in the PC7501 or the oscillator circuit on the target system. If you want to debug programs without the target system or change a frequency temporarily, you can check its operation before preparing an oscillator. If you want to use the internal oscillator circuit of the PC7501 as a main clock, choose "Generate" in the emulator debugger and specify a frequency you like to use for this clock supplied to an MCU.

Although you can change a frequency between 1.0 and 99.9 MHz by 0.1 MHz for the PC7501, do not specify a value exceeding the maximum input frequency of the X_{IN} of the MCU.

IMPORTANT

Notes on External Clock:

- The internal generator circuit is equipped for temporary debugging purposes. Temperature characteristics of frequencies are not guaranteed.
- Be sure to evaluate your system with an oscillator or oscillator module whose frequency is same as that of the internal oscillator circuit (internal clock) for final evaluation purposes.

3.5 Setting Switches

Figure 3.7 shows the positions of the switches of the M30850T-EPBM. Table 3.2 lists how to set each switch.

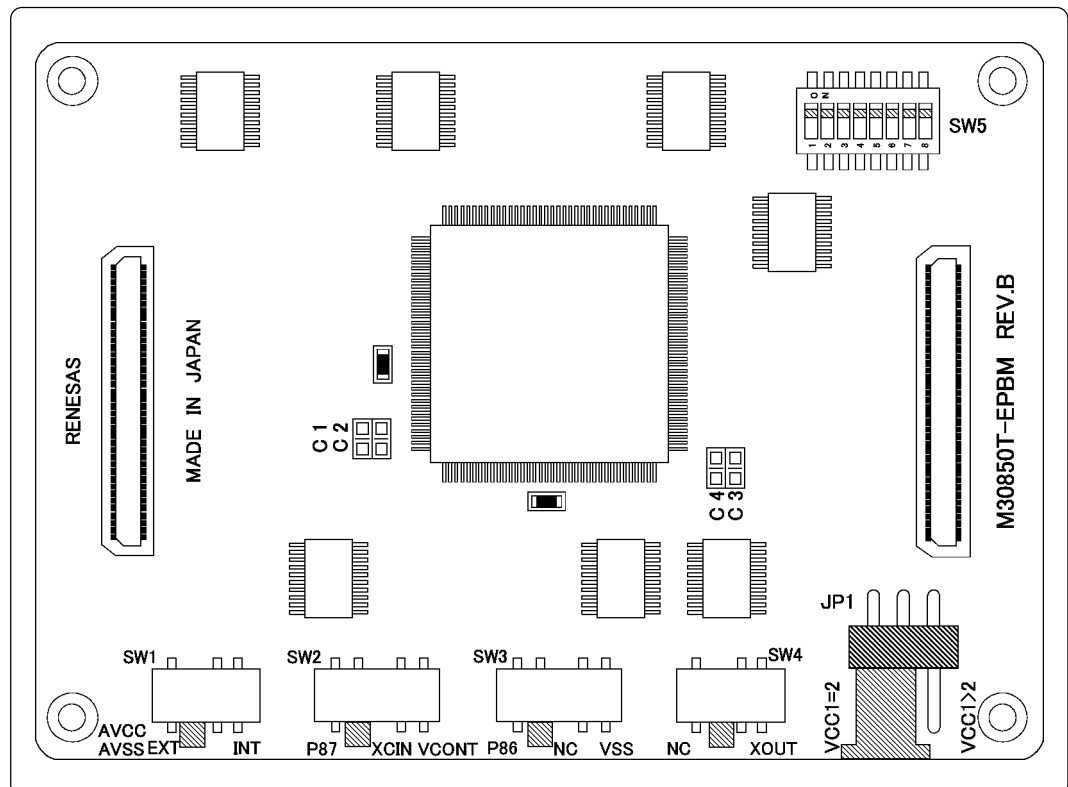

Figure 3.7 Positions of the switches

Table 3.2 Switch settings of the M30850T-EPBM (JP1, SW1 to SW4)





Signal	Switch	Setting	Description
VCC1 VCC2	JP1	 <p>(Factory-setting)</p>	$3.0\text{ V} \leq \text{VCC1} = \text{VCC2} \leq 5.5\text{ V}$
			$4.8\text{ V} \leq \text{VCC1} \leq 5.2\text{ V}$ and $3.3\text{ V} \leq \text{VCC2} < \text{VCC1}$
AVCC AVSS	SW1	 <p>(Factory-setting)</p>	Connects pins AVCC and AVSS of the MCU to the target system.
			Connects pin AVCC of the MCU to the internal power supply of the emulator, and connects pin AVSS to the GND in the emulator.
XCIN P87	SW2	 <p>(Factory-setting)</p>	Connects pin P87 of the MCU to the target system.
			Connects pin P87 of the MCU to the sub-clock oscillator circuit (32.768 kHz).
			Do not set to VCONT. Pin P87 is disconnected.
XCOUT P86	SW3	 <p>(Factory-setting)</p>	Connects pin P86 of the MCU to the target system.
			Does not connect pin P86 of the MCU.
			Do not set to VSS. Connects pin P86 to the VSS in the emulation probe.
XOUT	SW4	 <p>(Factory-setting)</p>	Does not connect pin XOUT of the MCU.
			Connects pin XOUT of the MCU to the target system.

Table 3.3 lists the examples of setting the switch SW5. It is necessary to change the setting when using the analog input port selection function of the A-D converter.

By setting the SW5, it is possible to set each analog input pin when selecting an analog input port. When selecting AN00 to AN07 or AN20 to AN27 for the analog input port select bits (bit 2 and bit 1 of 0394h), set the pins used for A-D conversion to ON, the pins not used to OFF.

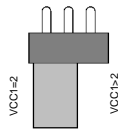
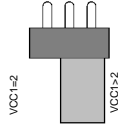
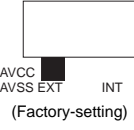
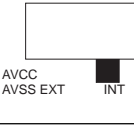
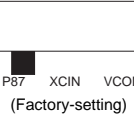
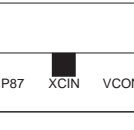
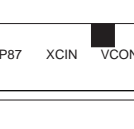
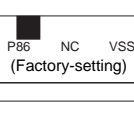
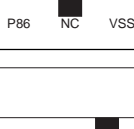
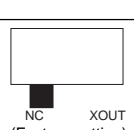
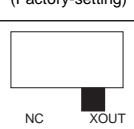
Table 3.3 Switch settings of the M30850T-EPBM (SW5)

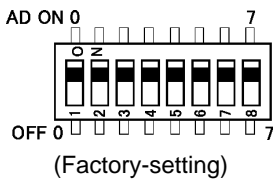
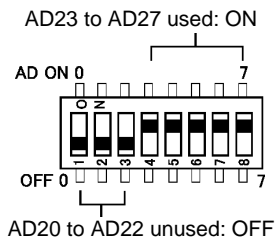
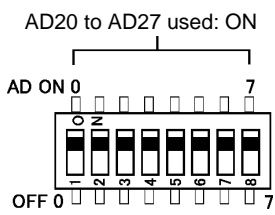
Analog input port	Setting	Description
When not using the analog input port selection function	 <p>(Factory-setting)</p>	<p>This is the setting when not using the analog input port selection function. When using this product with the conditions below, use this setting.</p> <ul style="list-style-type: none"> - When using the memory expansion mode - When using the microprocessor mode - When using the multi-port sweep mode - When selecting AN0 to AN7 for analog input port select bits - When selecting AN150 to AN157 for analog input port select bits
When using AN23 to AN27	 <p>AD23 to AD27 used: ON AD20 to AD22 unused: OFF</p>	<p>This is a setting when using the analog input port selection function and using AN23 to AN27 for analog input pins. Set the analog input pins to ON. With this setting, set the direction registers of ports P153 to P157 to input. Pins P150 to P152 can be used for I/O port, ISTxD0, ISCLK0 and ISRxD0.</p>
When using AN20 to AN27	 <p>AD20 to AD27 used: ON</p>	<p>This is a setting when using the analog input port selection function and using AN20 to AN27 for analog input pins. Set the analog input pins to ON. With this setting, set the direction registers of ports P150 to P157 to input. Pins P150 to P157 cannot be used for I/O port, ISTxD0, ISCLK0 and ISRxD0.</p>
When using AN04 to AN07	 <p>AD04 to AD07 used: ON AD00 to AD03 unused: OFF</p>	<p>This is a setting when using the analog input port selection function and using AN04 to AN07 for analog input pins. Set the analog input pins to ON. With this setting, set the direction registers of ports P154 to P157 to input. Pins P150 to P153 can be used for I/O port, ISTxD0, ISCLK0 and ISRxD0.</p>
When using AN03 to AN05 and AN25 to AN27	 <p>AD03 to AD05 used: ON AD25 to AD27 used: ON AD00 to AD02 unused: OFF AD20 to AD22 unused: OFF</p>	<p>This is a setting when using the analog input port selection function and using AN03 to AN05 and AN25 to AN27 for analog input pins. Set the analog input pins to ON. With this setting, set the direction registers of ports P153 to P157 to input. Pins P150 to P152 can be used for I/O port, ISTxD0, ISCLK0 and ISRxD0.</p>

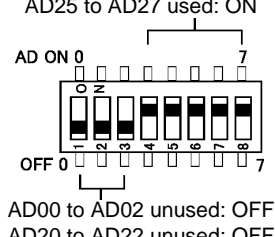
IMPORTANT

Notes on Switch JP1:

- If using this product when the voltage of VCC1 is higher than that of VCC2, set the JP1 to VCC1>2.
- When the JP1 is set to VCC1>2, the voltage of VCC2 on the target system should be 3.3 V or more.
- If using a CPU clock frequency of 30 MHz or more when the voltage of VCC1 is higher than that of VCC2, set the SFR area of the intelligent I/O function to 2-wait (set the PM13 bit to "1") when reading this area. This precaution only needs to be observed when using an emulator, and does not apply for the actual MCU.

Notes on Switch SW5:

- When using this product in memory expansion mode or microprocessor mode, be sure to set the SW5 same as the factory-setting (all ON).
- When setting the register below to use the analog input port selection function, you need to set the direction register of port P15 for a pin that performs A-D conversion to "input".
And you need to set the function selection register of port P15 for a pin that performs A-D conversion to "I/O port".

A-D0 control register 2 (address 394h)

b2,	b1	
1,	0	: AN00 to AN07
1,	0	: AN20 to AN27

Also, when the P0 group and P2 group are selected for A-D input, port P15 cannot be used as an I/O port. When setting the register above, port P15 cannot be used as an I/O port even if A-D conversion is halting.

- When setting the register below to use multi-port sweep mode, you need to set the direction register of port P15 for a pin that performs A-D conversion to "input".
And you need to set the function selection register of port P15 for a pin that performs A-D conversion to "I/O port".

A-D0 control register 4 (address 392h)

b3,	b2	
1,	0	: AN0 to AN7, AN00 to AN07
1,	0	: AN0 to AN7, AN20 to AN27

Also, when the P0 group and P2 group are used for multi-port sweep mode, port P15 cannot be used as an I/O port. When setting the register above, port P15 cannot be used as an I/O port even if A-D conversion is halting.

- Because a converter board and other devices are used between the evaluation MCU and the target system, the A-D converter operates differently from an actual MCU. Make the final evaluation of the A-D converter using an actual MCU.

3.6 A-D Conversion Bypass Capacitor

There is a foot pattern on the M30850T-EPBM board for mounting bypass capacitors for the A-D conversion circuit. Mount applicable bypass capacitors as occasion demands. Figure 3.8 shows where they are installed.

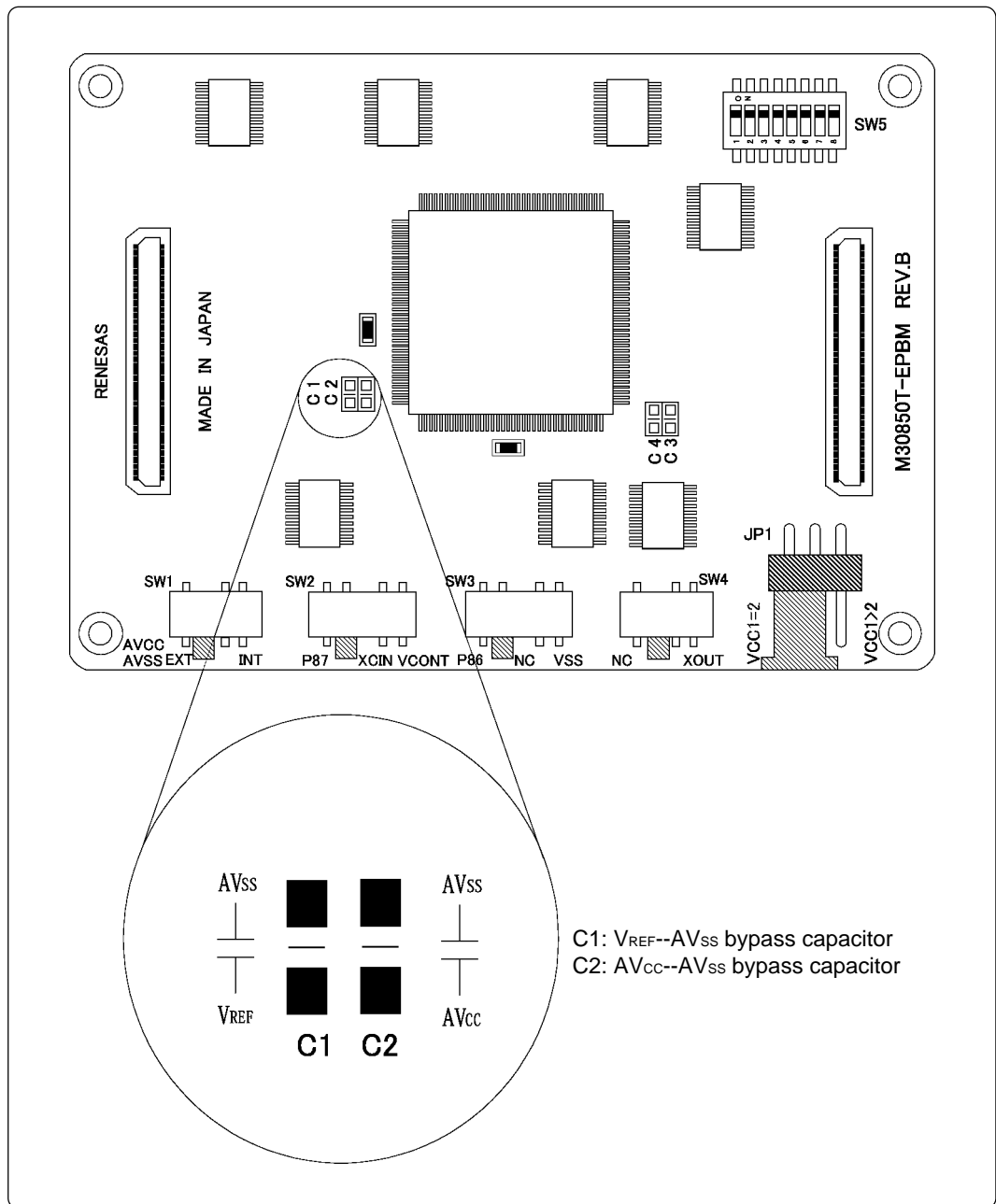

Figure 3.8 Foot pattern for the A-D conversion bypass capacitor

IMPORTANT

Note on the A-D Converter:

- Because a converter board and other devices are used between the evaluation MCU and the target system, the A-D converter operates differently from an actual MCU. Make the final evaluation of the A-D converter using an actual MCU.

3.7 Connecting the PC7501

Figure 3.9 shows how to connect the PC7501 and the emulation probe.

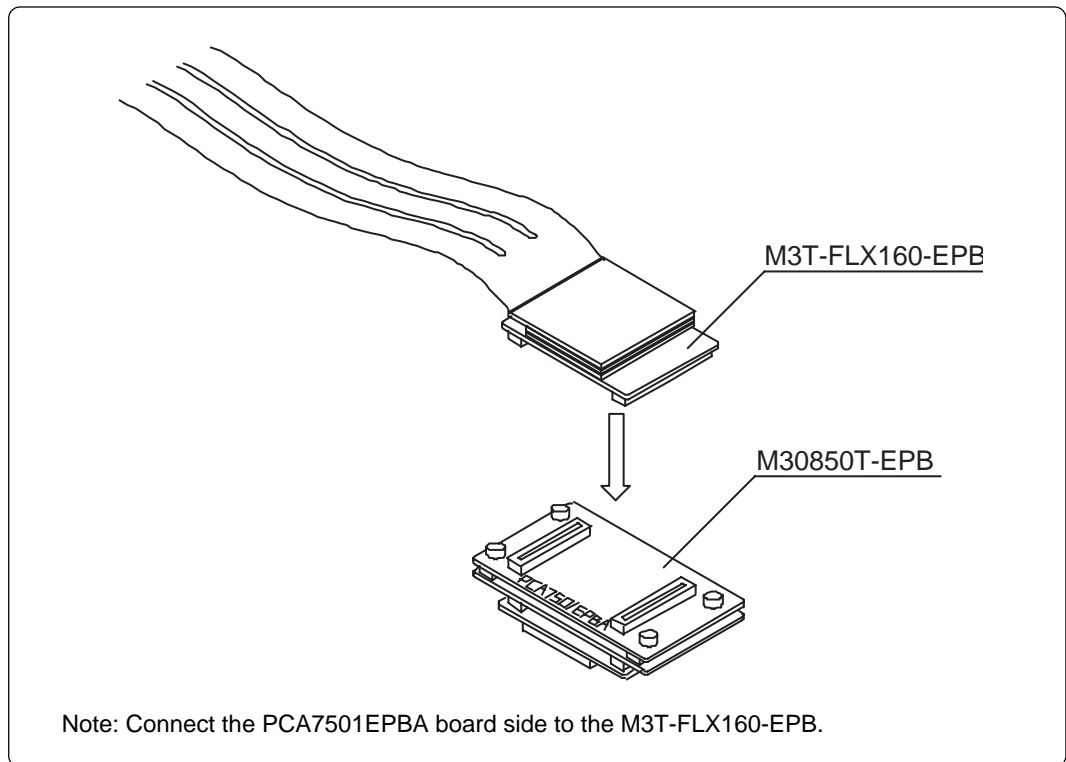

Figure 3.9 Connecting the PC7501 and emulation probe

CAUTION

Note on Connecting the Cable:

- When connecting the emulation probe, be sure to hold the both sides of the emulation probe horizontally and insert it directly.
- Connect the PCA7501EPBA board to the M3T-FLX160-EPB.
- Always shut OFF power before connecting the emulation probe. Otherwise, internal circuits may be damaged.

3.8 Connecting the Target System

There are eight ways available to connect the emulator to target systems as shown in Figure 3.10.

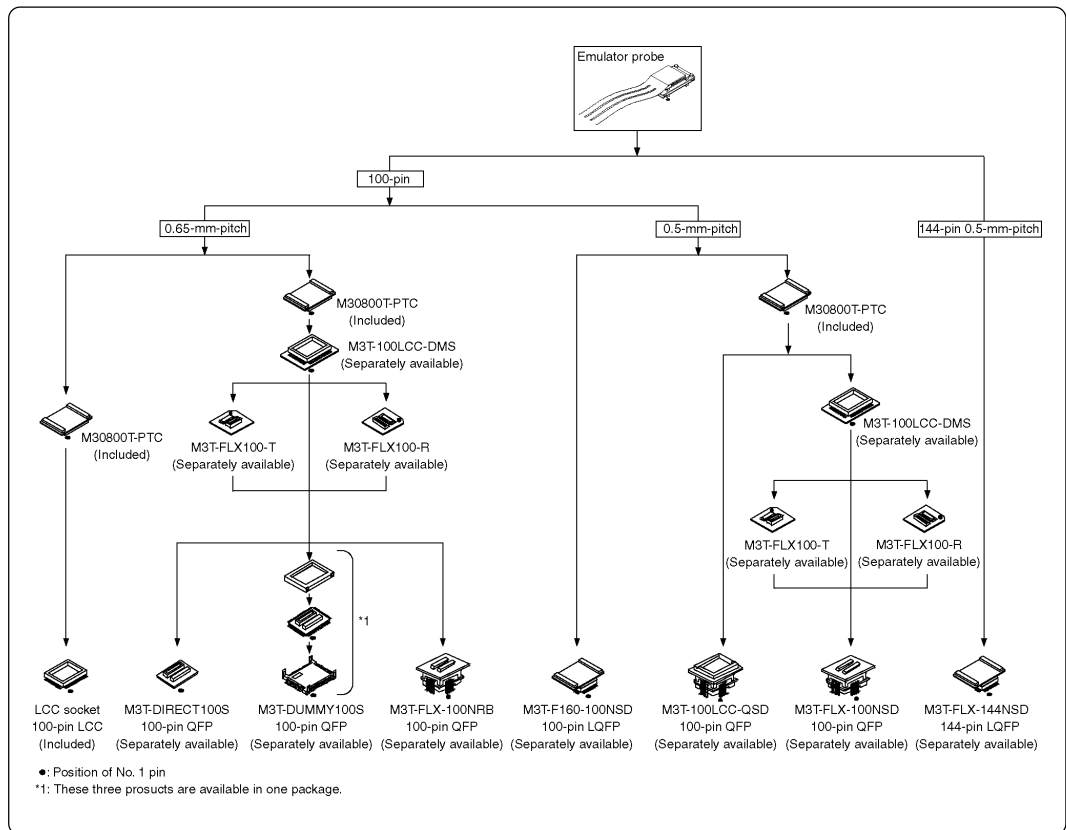

Figure 3.10 Connecting the target system

CAUTION

Note on Connecting the Target System:

- Take care not to attach the converter board in a wrong direction. It may cause a fatal damage to the emulator.

(1) Connecting to a 100-pin LCC Socket

When connecting the emulation probe to a 100-pin LCC socket (Yamaichi Electronics Co., Ltd.: IC61-1004-051 etc.) on the target system, following the procedure below.

- (1) Attach the CN2 side of the M30850T-EPB to the CN2 side of the M30800T-PTC.
- (2) Attach the M30800T-PTC to the 100-pin LCC socket.

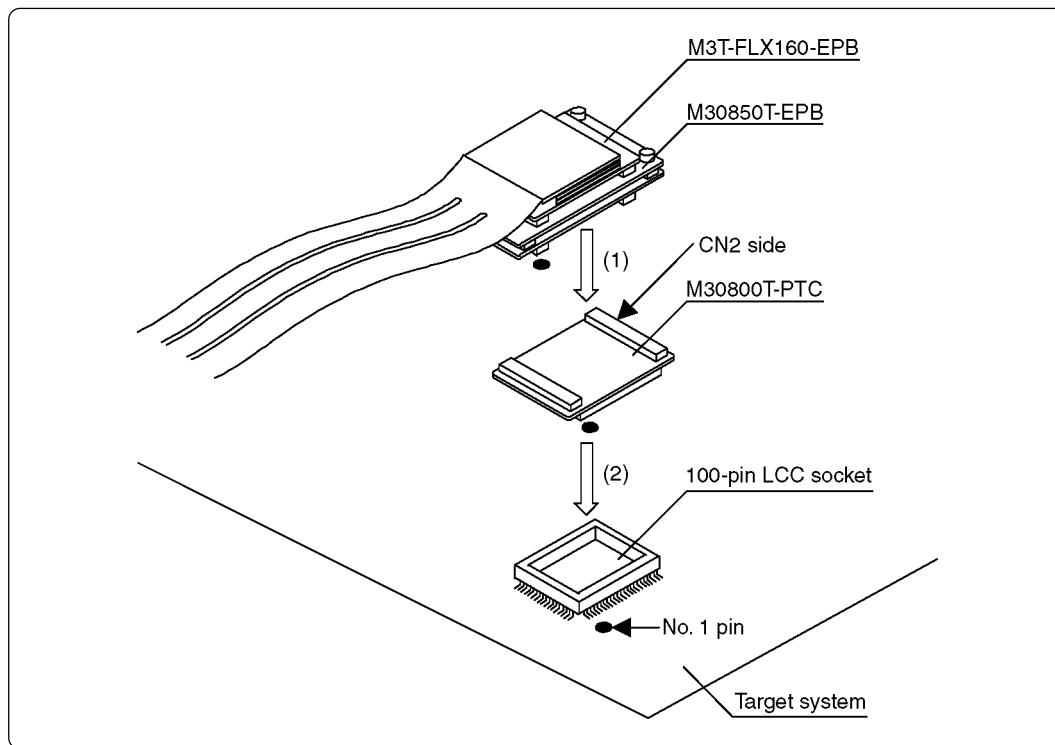

Figure 3.11 Connecting to a 100-pin LCC socket

CAUTION

Notes on Connecting the Target System:

- Take care not to attach the converter board in a wrong direction. It may cause a fatal damage to the emulator.
- The small connectors of the M30800T-PTC are guaranteed for only 50 insertion/removal iterations.
- For purchasing the IC61-1004-051 or for technical information, contact Yamaichi Electronics Co., Ltd.

<http://www.yamaichi.co.jp/e/index.shtml>

(2) Connecting to a 100-pin 0.65-mm-pitch Foot Pattern (Part 1)

Figure 3.12 shows how to connect the emulation probe to a 100-pin 0.65-mm-pitch foot pattern on the target system with the M3T-DUMMY100S (not included), and here following is its procedure. For details on the M3T-100LCC-DMS and M3T-DUMMY100S, refer to each user's manual.

- (1) Attach the M3T-DUMMY100S to the target system.
For details on how to attach the M3T-DUMMY100S to the target system, see the user's manual of the M3T-DUMMY100S.
- (2) Attach the M3T-100LCC-DMS to the M3T-DUMMY100S.
- (3) Attach the M30800T-PTC to the M30850T-EPB.
- (4) Attach the M30800T-PTC to the M3T-100LCC-DMS.

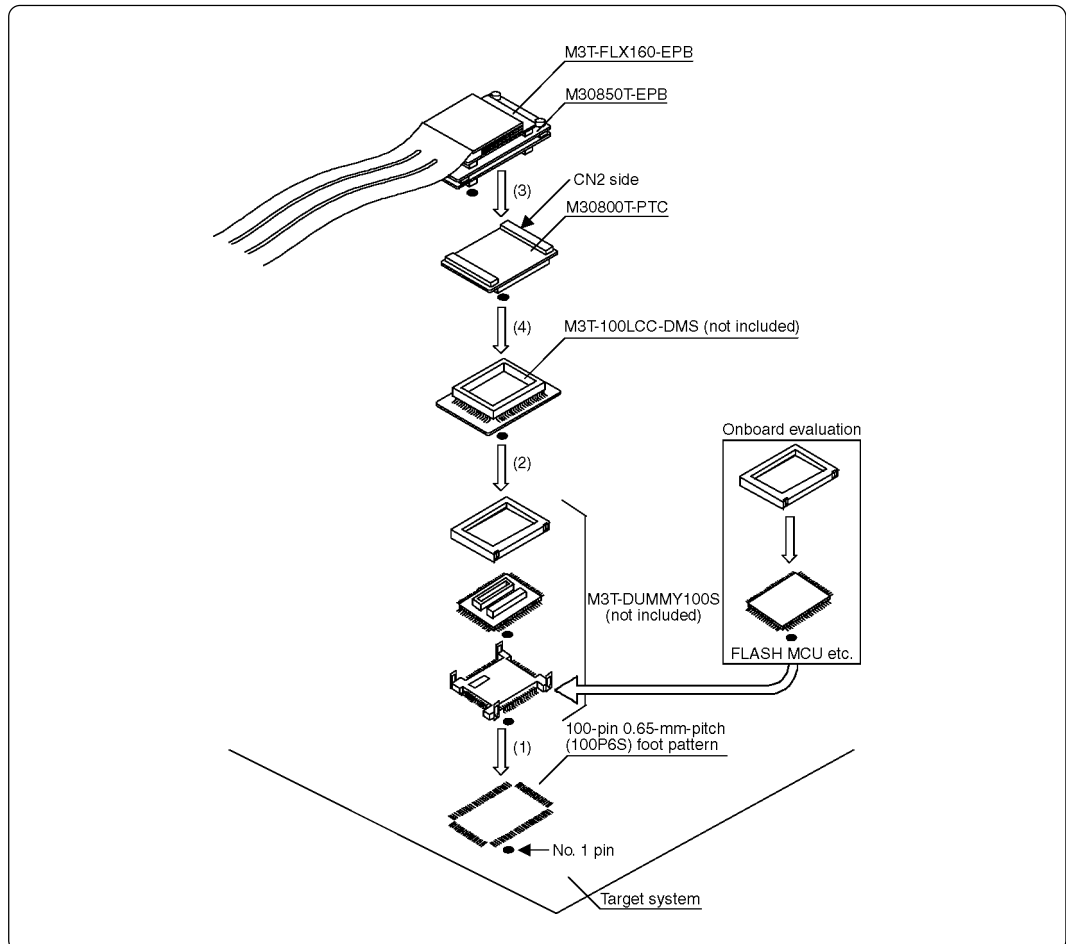

Figure 3.12 Connecting to a 100-pin 0.65-mm-pitch foot pattern (1/3)

CAUTION

Notes on Connecting the Target System:

- Take care not to attach the converter board in a wrong direction. It may cause a fatal damage to the emulator.
- The small connectors of the M3T-100LCC-DMS and M3T-DUMMY100S are guaranteed for only 20 insertion/removal iterations.
- The small connectors of the M30800T-PTC are guaranteed for only 50 insertion/removal iterations.

(3) Connecting to a 100-pin 0.65-mm-pitch Foot Pattern (Part 2)

Figure 3.13 shows how to connect the emulation probe to a 100-pin 0.65-mm-pitch foot pattern on the target system with the M3T-DIRECT100S (not included), and here following is its procedure. For details on the M3T-100LCC-DMS and M3T-DIRECT100S, refer to each user's manual.

- (1) Attach the M3T-DIRECT100S to the target system.
For details on how to attach the M3T-DIRECT100S to the target system, see the user's manual of the M3T-DIRECT100S.
- (2) Attach the M3T-100LCC-DMS to the M3T-DIRECT100S.
- (3) Attach the M30800T-PTC to the M30850T-EPB.
- (4) Attach the M30800T-PTC to the M3T-100LCC-DMS.

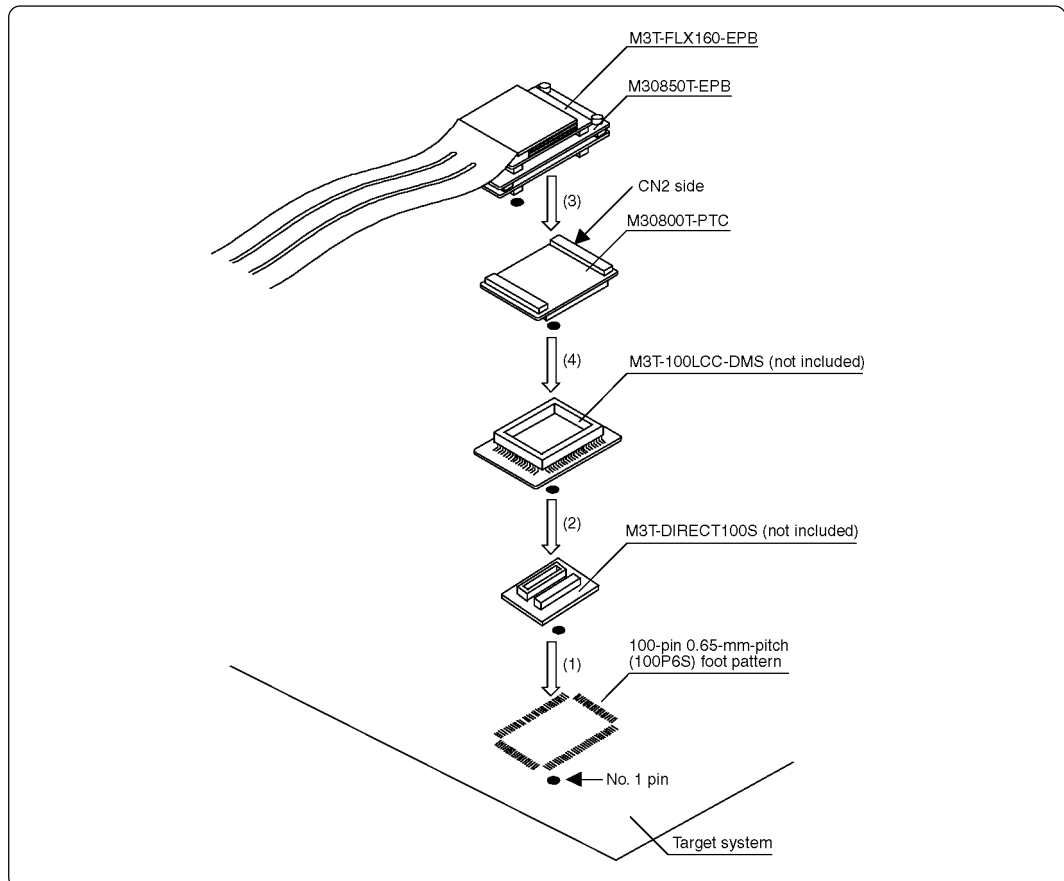

Figure 3.13 Connecting to a 100-pin 0.65-mm-pitch foot pattern (2/3)

CAUTION

Notes on Connecting the Target System:

- Take care not to attach the converter board in a wrong direction. It may cause a fatal damage to the emulator.
- The small connectors of the M3T-100LCC-DMS and M3T-DIRECT100S are guaranteed for only 20 insertion/removal iterations.
- The small connectors of the M30800T-PTC are guaranteed for only 50 insertion/removal iterations.

(4) Connecting to a 100-pin 0.65-mm-pitch Foot Pattern (Part 3)

Figure 3.14 shows how to connect the emulation probe to a 100-pin 0.65-mm-pitch foot pattern on the target system with the M3T-FLX-100NRB (not included), and here following is its procedure. For details on the M3T-100LCC-DMS and M3T-FLX-100NRB, refer to each user's manual.

- (1) Attach the M3T-FLX-100NRB to the target system.
For details on how to attach the M3T-FLX-100NRB to the target system, see the user's manual of the M3T-FLX-100NRB.
- (2) Attach the M3T-100LCC-DMS to the M3T-FLX-100NRB.
- (3) Attach the M30800T-PTC to the M30850T-EPB.
- (4) Attach the M30800T-PTC to the M3T-100LCC-DMS.

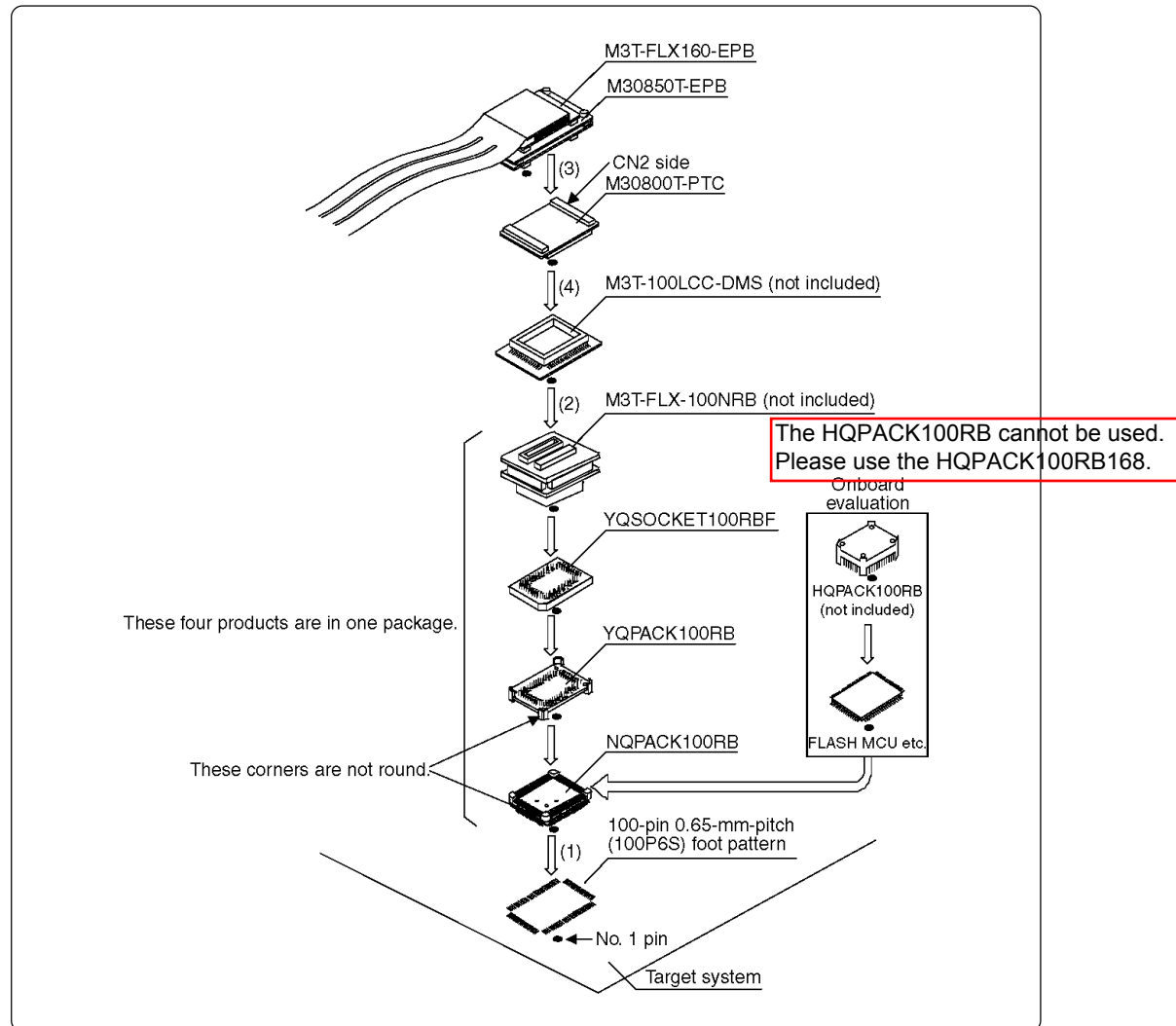

Figure 3.14 Connecting to a 100-pin 0.65-mm-pitch foot pattern (3/3)

CAUTION

Notes on Connecting the Target System:

- Take care not to attach the converter board in a wrong direction. It may cause a fatal damage to the emulator.
- The small connectors of the M3T-100LCC-DMS and M3T-FLX-100NRB are guaranteed for only 20 insertion/removal iterations.
- The small connectors of the M30800T-PTC are guaranteed for only 50 insertion/removal iterations.

(5) Connecting to a 100-pin 0.5-mm-pitch Foot Pattern (Part 1)

Figure 3.15 shows how to connect the emulation probe to a 100-pin 0.5-mm-pitch foot pattern on the target system with the M3T-100LCC-QSD (not included), and here following is its procedure. For details on the M3T-100LCC-QSD, refer to its user's manual.

- (1) Attach the M3T-100LCC-QSD to the target system.
For details on how to attach the M3T-100LCC-QSD to the target system, see the user's manual of the M3T-100LCC-QSD.
- (2) Attach the M30800T-PTC to the M30850T-EPB.
- (3) Attach the M30800T-PTC to the M3T-100LCC-QSD.

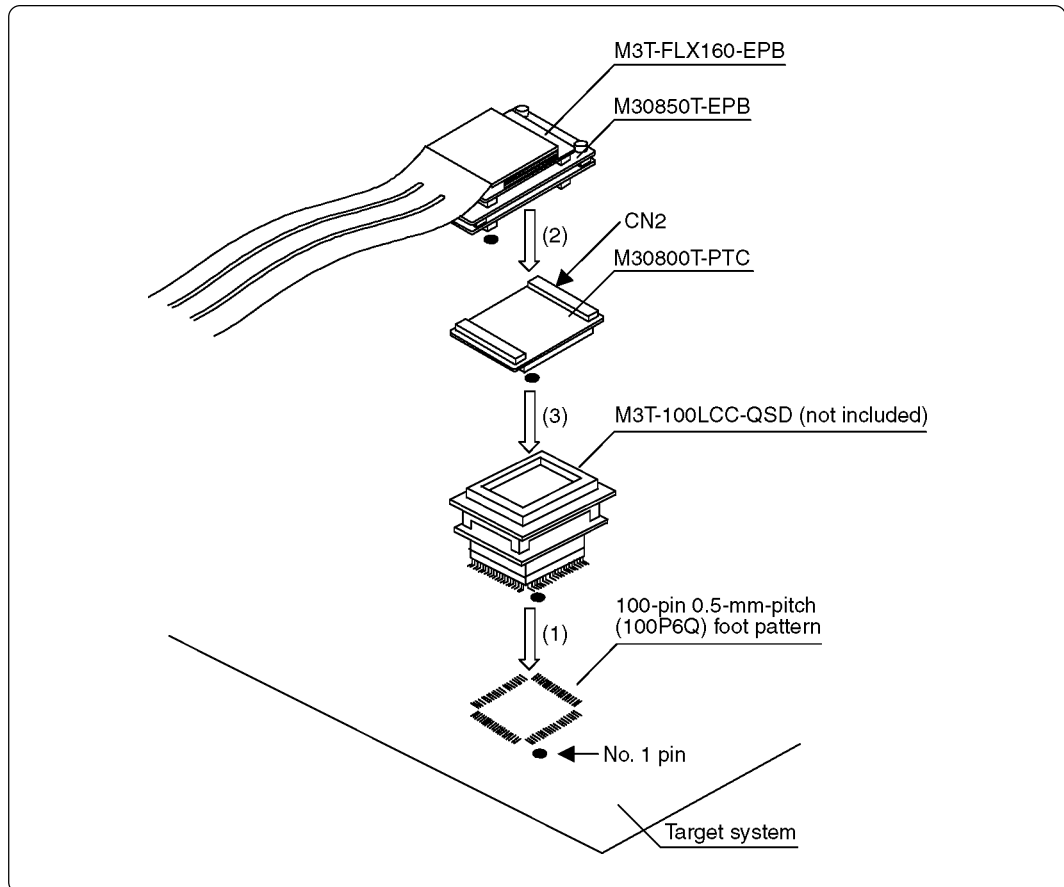

Figure 3.15 Connecting to a 100-pin 0.5-mm-pitch foot pattern (1/3)

CAUTION

Notes on Connecting the Target System:

- Take care not to attach the converter board in a wrong direction. It may cause a fatal damage to the emulator.
- The small connectors of the M30800T-PTC are guaranteed for only 50 insertion/removal iterations.

(6) Connecting to a 100-pin 0.5-mm-pitch Foot Pattern (Part 2)

Figure 3.16 shows how to connect the emulation probe to a 100-pin 0.5-mm-pitch foot pattern on the target system with the M3T-FLX-100NSD (not included), and here following is its procedure. For details on the M3T-100LCC-DMS and M3T-FLX-100NSD, refer to each user's manual.

- (1) Attach the M3T-FLX-100NSD to the target system.
For details on how to attach the M3T-FLX-100NSD to the target system, see the user's manual of the M3T-FLX-100NSD.
- (2) Attach the M3T-100LCC-DMS to the M3T-FLX-100NSD.
- (3) Attach the M30800T-PTC to the M30850T-EPB.
- (4) Attach the M30800T-PTC to the M3T-100LCC-DMS.

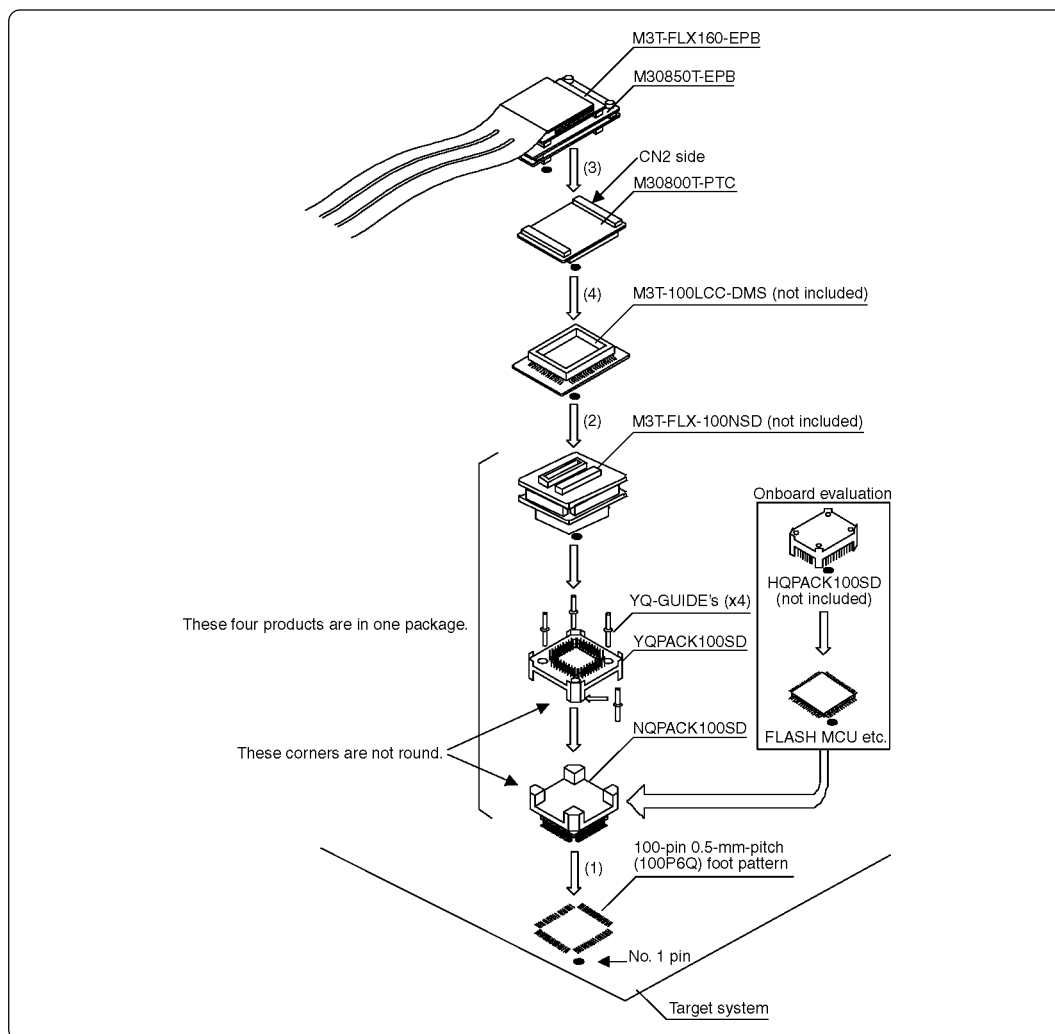

Figure 3.16 Connecting to a 100-pin 0.5-mm-pitch foot pattern (2/3)

CAUTION

Notes on Connecting the Target System:

- Take care not to attach the converter board in a wrong direction. It may cause a fatal damage to the emulator.
- The small connectors of the M3T-100LCC-DMS and M3T-FLX-100NSD are guaranteed for only 20 insertion/removal iterations.
- The small connectors of the M30800T-PTC are guaranteed for only 50 insertion/removal iterations.

(7) Connecting to a 100-pin 0.5-mm-pitch Foot Pattern (Part 3)

Figure 3.17 shows how to connect the emulation probe to a 100-pin 0.5-mm-pitch foot pattern on the target system with the M3T-F160-100NSD (not included), and here following is its procedure. For details on the M3T-F160-100NSD, refer to its user's manual.

- (1) Mount the NQPACK100SD included with the M3T-F160-100NSD to the target system.
For details on how to connect the M3T-F160-100NSD, see its user's manual.
- (2) Attach the YQPACK100SD included with the M3T-F160-100NSD to the NQPACK100SD.
- (3) Insert the YQ-GUIDE's included with the YQPACK100SD to the YQPACK100SD.
- (4) Attach the M30850T-EPB to the M3T-F160-100NSD.
- (5) Attach the M3T-F160-100NSD to the YQPACK100SD.

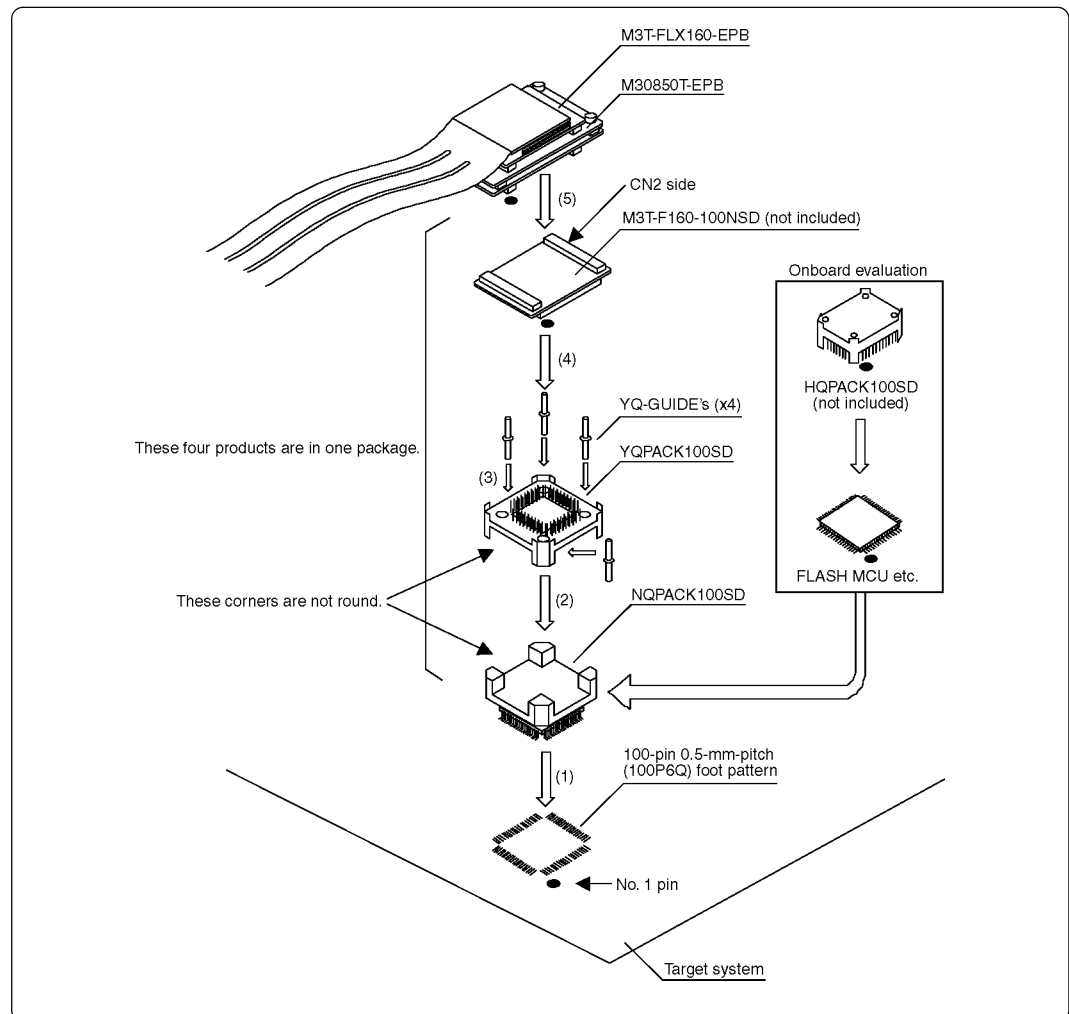

Figure 3.17 Connecting to a 100-pin 0.5-mm-pitch foot pattern (3/3)

CAUTION

Notes on Connecting the Target System:

- Take care not to attach the converter board in a wrong direction. It may cause a fatal damage to the emulator.
- The small connectors of the M3T-F160-100NSD are guaranteed for only 50 insertion/removal iterations.

MEMO

Chapter 4. Usage

This chapter describes from turning on the power of this product to starting up the emulator debugger.

4.1 Turning On the Power	48
(1) Checking the Connection of the Emulator System	48
(2) Turning ON/OFF the Power	48
(3) LED Display When the Emulator Starts Up Normally	49
4.2 Downloading Firmware	50
(1) When It is Necessary to Download Firmware	50
(2) Downloading Firmware in Maintenance Mode	50
4.3 Starting Up the Emulator Debugger (Setting the EMEM Dialog Box)	51
(1) Setting the Debug Monitor Bank Address	52
(2) Selecting a Processor Mode	52
(3) Setting Emulation Memory	53
(4) Emulation Memory Allocation as Expansion Area	53
(5) Referring MCU STATUS	55
4.4 Self-check	55
(1) Self-check Procedure	55
(2) If an Error is Detected in the Self-check	55

Chapter 4. Usage

4.1 Turning On the Power

(1) Checking the Connection of the Emulator System

Before turning the power ON, check the connection of the interface cable with host machine, PC7501, emulation probe, and target system.

(2) Turning ON/OFF the Power

- Turn ON the power of the emulator and target system as simultaneously as possible.
- Turn OFF the power of the emulator and target system as simultaneously as possible.
- Do not leave either the emulator or target system powered on, because of leakage current the internal circuits may be damaged.
- When turning ON the power again after shutting OFF the power, wait for about 10 seconds.

IMPORTANT

Notes on Power Supply:

- The emulator's pin Vcc is connected to the target system in order to monitor target system voltage. For this reason, the emulator cannot supply power to the target system. Therefore, provide the target system with a separate power supply from that of the emulator.
- Keep target system power supply voltage within the MCU's specified range (3.0 to 5.5 V).
- Do not change target system power supply voltage after power has been activated.

(3) LED Display When the Emulator Starts Up Normally

Figure 4.1 shows upper panel LED lighting status when the emulator started up properly. Check it when starting up the emulator system.

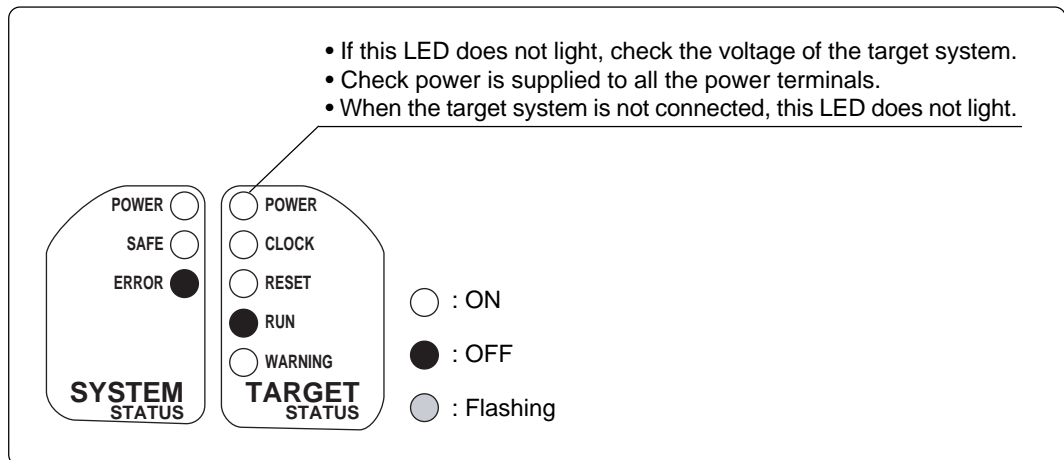

Figure 4.1 LED display when the power turned on PC7501

IMPORTANT

Note on Memory Expansion and Microprocessor Modes:

- To use memory expansion or microprocessor mode, be sure to set pins RDY*, HOLD* and NMI* so that they are not active at start-up. Otherwise the emulator system will not start up correctly.

Note on CLOCK LED:

- If CLOCK LED does not turn on, check the following:
 - (1) Immediately after starting PC7501 (before starting the emulator debugger)
--> Check if the oscillation circuit within the PC7501 emulator main unit oscillates normally.
 - (2) After starting the emulator debugger (after setting the Init dialog box)
--> Check the oscillation circuit set in the Init dialog box oscillates normally.

4.2 Downloading Firmware

(1) When It is Necessary to Download Firmware

It is necessary to download the firmware when:

- (1) you use this product for the first time
- (2) the firmware has been upgraded
- (3) the emulator debugger has been upgraded
- (4) you use this product with a PC7501 which was used with other emulation probe before

When you use this product for the first time or when the power is unexpectedly shut down during firmware download, redownload the firmware in maintenance mode.

(2) Downloading Firmware in Maintenance Mode

Download the firmware in maintenance mode as explained here following. **The target system must not be connected when downloading the firmware.**

- (1) Set the interface select switch on the rear panel of the PC7501 to the LPT side and connect the LPT parallel interface cable to the PC7501 and the host machine.
- (2) Within 2 seconds of activating power to the emulator, press the RESET switch on the PC7501 upper panel to switch to maintenance mode.

Switched to maintenance mode, the SAFE SYSTEM STATUS LED begins to flash.

- (3) Start up the emulator debugger. When the Init dialog box setup is complete, the dialog which urges to download the firmware will appear. Download the firmware following messages. Required time for downloading the firmware is about 60 seconds.

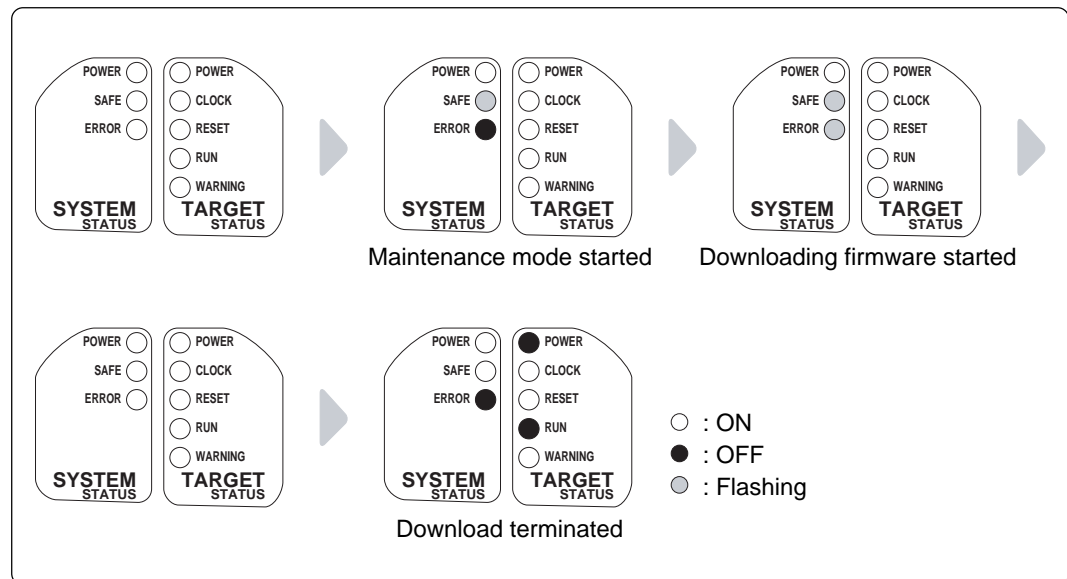

Figure 4.2 Downloading firmware in maintenance mode

CAUTION

Note on Downloading Firmware:

- Do not shut OFF power while the firmware is being downloaded. Doing so, the emulator will not start up properly. If power is shut OFF by mistake, redownload the firmware in maintenance mode.

4.3 Starting Up the Emulator Debugger (Setting the EMEM Dialog Box)

The EMEM dialog box will appear after setting the Init dialog box by starting up the emulator debugger or completing downloading the firmware. Here explains how to set a processor mode of the target MCU, allocate the emulation memory and set the emulator work area. Figure 4.3 shows the EMEM dialog box display.

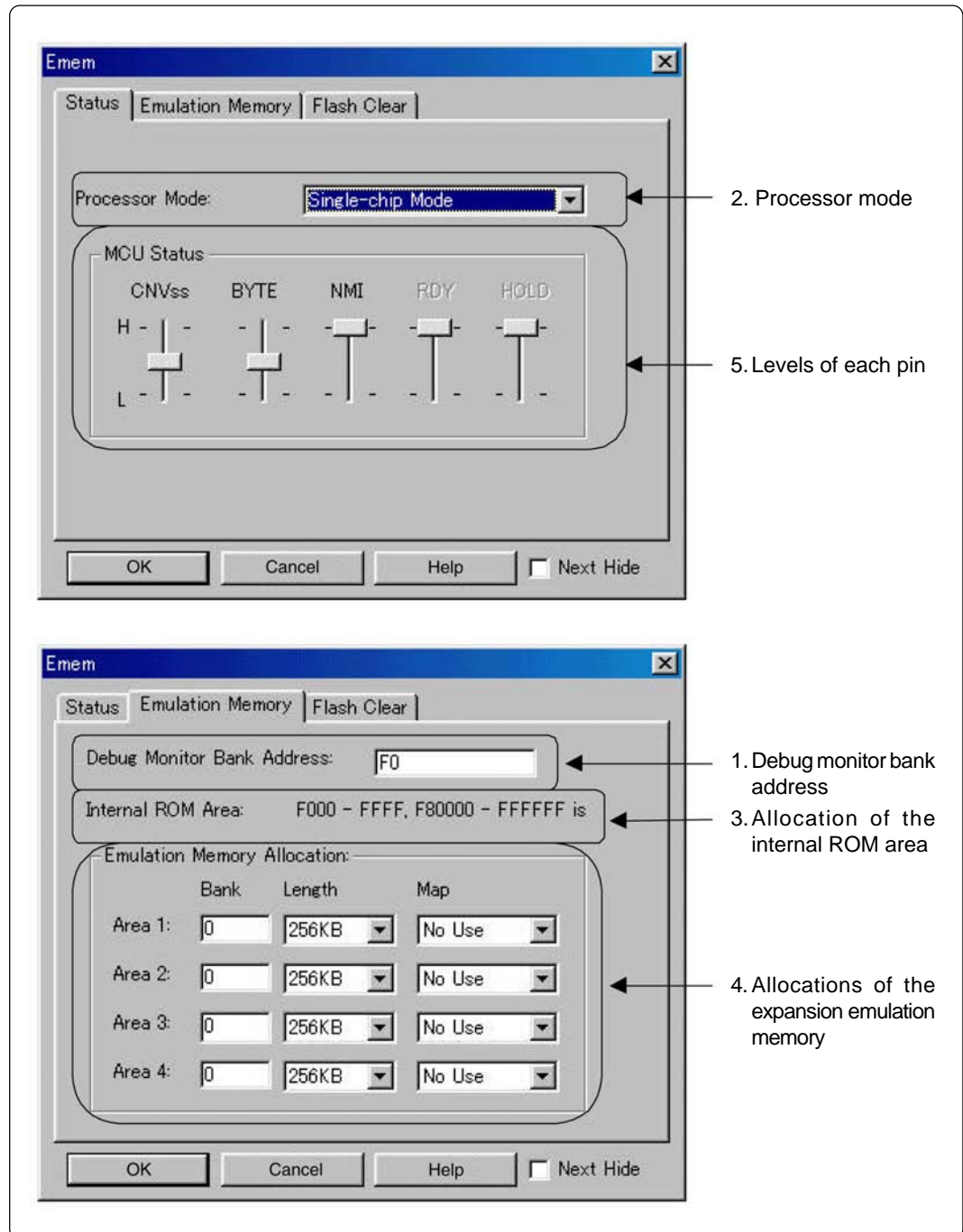

Figure 4.3 EMEM dialog box

(1) Setting the Debug Monitor Bank Address

With this product, consecutive 64 KB of the emulator's work area are allocated to the debug monitor. When "F0" is specified, 64 KB starting from address F00000h are allocated for use by the debug monitor. Specify an unused area.

IMPORTANT

Notes on Setting a Debug Monitor Bank Address:

- It is not possible to view or set the content of the specified area. Even on the memory window or in the reverse assemble area of the program/source windows, the content of this area is not displayed correctly though it can be displayed.
- The below bank addresses cannot be set for the debug monitor.
 - (1) MCU internal resources (ROM, RAM and SFR areas)
 - (2) Multiplex areas
 - (3) Interrupt vector area

(2) Selecting a Processor Mode

Here explains about the setting of the processor modes. The selectable modes are listed in Table 4.1.

Table 4.1 Selecting a processor mode

Processor mode	Select from the list
Single-chip mode	Single-chip Mode
Memory expansion mode	Memory Expansion Mode 8 Bit
	Memory Expansion Mode 16 Bit
Microprocessor mode	Microprocessor Mode 8 Bit
	Microprocessor Mode 16 Bit

IMPORTANT

Notes on Selecting a Processor Mode:

- When setting single-chip mode or memory expansion mode, the level of pin CNVSS of the MCU status should be "L". The MCU status shows the pin level of the target system.
- When setting microprocessor mode, the level of pin CNVSS of the MCU status should be "H".
- When setting memory expansion mode or microprocessor mode, pins RDY* and HOLD* of the target system should be "H".
- When the target system is not connected, all modes are available.

(3) Setting Emulation Memory

This product has two kinds of emulation memory and how to allocate is different depending on which processor mode is selected. Table 4.2 shows how to set the emulation memory for each processor mode.

Table 4.2 Setting the emulation memory

Processor mode	Internal flash memory	Emulation memory for expansion
Single-chip Mode	F000h--FFFFh, F80000h--FFFFFFh are allocated automatically.	Cannot be used.
Memory Expansion Mode	F000h--FFFFh, F80000h--FFFFFFh are allocated automatically.	Possible to specify the desired area between Area 1 and 4.
Microprocessor Mode	Cannot be used.	Possible to specify the desired area between Area 1 and 4.

(4) Emulation Memory Allocation as Expansion Area

This section explains about setting emulation memory for expansion purposes in memory expansion mode and microprocessor mode. To use emulation memory as expansion area, set memory allocation as indicated here below. Emulation memory specifications are given in Table 4.3.

- (1) Setting bank address (Bank): Specify the bank address of the area to be allocated for expansion as a hexadecimal number.

For example, specifying "C0" allocates the bank from address C00000h.

When 256 KB is specified as the Length, bank addresses can be specified from 00, 04, 08 up to FC in 256KB blocks.

When 1 MB is specified as the Length, bank addresses can be specified from 00, 10, 20 up to F0 in 1MB blocks.

- (2) Specifying area size (Length): Specify the size of the specified expansion area. The area from the specified address to the size specified here is allocated as external area and internal area. Length can be specified as 256 KB or 1 MB.

- (3) Specifying area map (Map): Select whether the specified area is to be allocated as internal area (used as emulation memory) or external area (used by an external device, etc.).

- When INTERNAL is specified: This bank is allocated as internal area and used for expansion.
- When EXTERNAL is specified: This bank is allocated as external area and used by the target system as an external resource.
- When No Use is specified: This bank is allocated as external area and used by the target system as an external resource.

Areas not specified here are allocated as external area. The only difference from the area specified as EXTERNAL area is download speed. Download to the area specified as EXTERNAL area is faster than to the other unspecified areas.

IMPORTANT

Notes on Using Emulation Memory for Expansion:

- When single-chip mode or memory expansion mode is set as a processor mode, internal ROM area is automatically allocated to the internal flash ROM. Therefore, it is not necessary to deliberately specify emulation memory as expansion area in order to allocate the internal ROM area.
- The 4MB memory mounted in the product can be allocated out. **Set memory allocation so that the total of the 4 length values does not exceed the emulation memory size (4 MB). However, the emulation memory is 3.25 MB in memory expansion mode.**
- **Be careful that the specified areas do not overlap one another.**
- Do not set the following areas for memory allocation of the MCU. Set these areas referring the specifications of the MCU.
 - (1) Area allocated for multiplex bus
 - (2) Unusable area
- Memory in the emulator is automatically selected as reset vector area regardless of settings.
- Except for the SFR, RAM, ROM and internally reserved areas, all areas other than the set area are externally accessible.
- MCU internal resources are automatically selected as SFR and RAM areas regardless of settings.

Table 4.3 Specifications of expansion emulation memory

Maximum operating frequency	32 MHz, 1ø + 1ø
Number of area which can be set	Max. 4 areas
Area size	Successive 256 KB or 1 MB (Can be mixed)
Emulation memory size	Total of 4 areas: 4 MB
Possible banks to be set	(1) For 256KB area X0h, X4h, X8h, XCh bank e.g.) 20 bank, 64 bank, A8 bank, EC bank etc. (2) For 1MB area X0h bank e.g.) 20 bank, 40 bank, 80 bank, A0 bank etc.

IMPORTANT

Note on Memory Access:

- When setting memory expansion mode as a processor mode, it may be changed to memory expansion mode temporarily before the user program itself changes from single-chip mode to memory expansion mode.

Take due consideration on this phenomenon in the following cases:

- (1) Immediately before executing the program after setting a software break
- (2) Immediately after stopping the program when a software break is set

(5) Referring MCU STATUS

It is possible to confirm each level of pins BYTE, CNVSS, RDY*, HOLD*, NMI* on the target system.

IMPORTANT

Notes on MCU STATUS:

- The status of pins of an MCU is displayed in the "MCU STATUS" of the EMEM dialog box. Confirm if it matches with the processor mode.
- Check that "RDY*" and "HOLD*" are set to "H". If they are set to the "L" level, the MCU itself is in the standby state. The emulator debugger displays an error message because it receives no response from the MCU.

4.4 Self-check

(1) Self-check Procedure

To run the emulator self-check, do so as explained here below. While the self-check is in progress, LEDs will change as shown in Figure 4.4.

- (1) If the target system is connected, disconnect it.
- (2) Within 2 seconds of activating power to the emulator, press the system reset switch on the emulator upper panel to switch the emulator to maintenance mode.
- (3) Check the "SAFE" LED starts flashing and then press the system reset switch again.
- (4) The self-check will start. If the normal result is displayed in about 30 seconds, the self-check terminated normally.

(2) If an Error is Detected in the Self-check

If the self-check does not result normally (ERROR 1 to ERROR 4 in Figure 4.4), check the following.

- Recheck the connection of the emulation probe and PC7501.
- Redownload the proper firmware.

CAUTION

Note on the Self-check:

- If the self-check does not result normally (excluding target system errors), the emulation probe may be damaged. Then contact your local distributor.

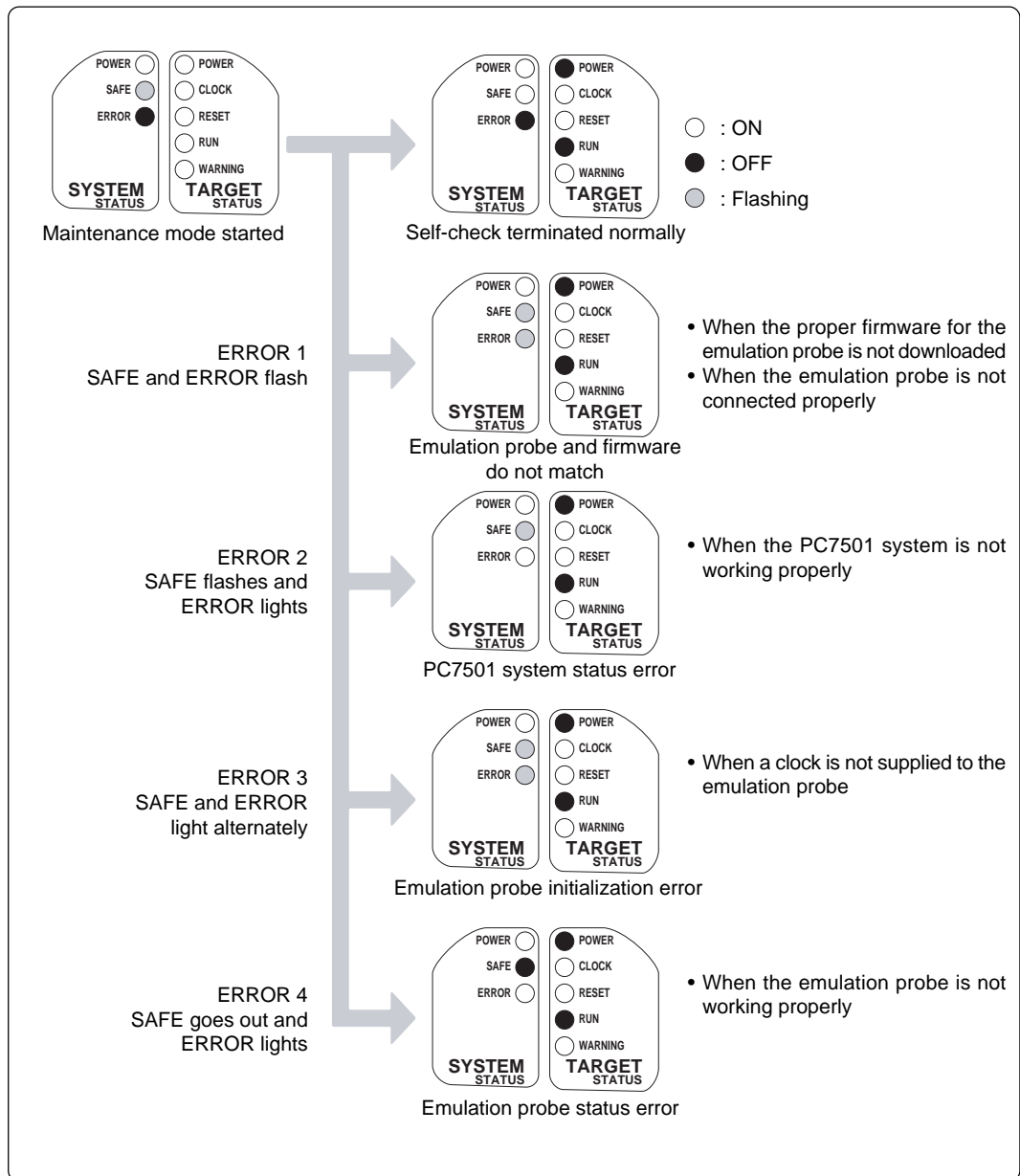

Figure 4.4 Self-check procedure

Chapter 5. Specifications

This chapter describes specifications of this product.

5.1 Specifications	58
5.2 Connection Diagrams	59
5.3 External Dimensions	61
(1) External Dimensions of the Emulation Probe	61
(2) External Dimensions of Converter Board M30800T-PTC	62
(3) External Dimensions of Converter Board M3T-F160-100NSD	63
(4) External Dimensions of Converter Board M3T-FLX-144NSD	63

Chapter 5. Specifications

5.1 Specifications

Table 5.1 lists the specifications of the M30850T-EPB.

Table 5.1 Specifications of the M30850T-EPB

Emulator	PC7501	
Applicable MCU	M32C/80, 84, 85 and 85 Groups (Supports up to max. 512K + 4K of ROM, 24K of RAM)	
Usable mode	Single-chip mode Memory expansion mode Microprocessor mode	
Emulation memory	(1) 516 KB for internal ROM of MCU (Fixed F000h--FFFFh, F80000h--FFFFFFh, maximum operating frequency: 32 MHz) (2) 4 MB for expansion area (changeable) (Possible to allocate by 256 KB or 1 MB, maximum operating frequency: 32 MHz, 1ø + 1ø)	
Maximum operating frequency	VCC1 = VCC2 = 4.2 to 5.5 V: 32 MHz VCC1 = VCC2 = 3.0 to 5.5 V: 24 MHz	
Clock supply	X _{IN} -X _{OUT}	Internal oscillator circuit board (OSC-3) Switchable to an oscillator circuit of the target system or the internal oscillator circuit input
	X _{CIN} -X _{COU} T	Internal oscillator circuit board (32.768 kHz fixed) Switchable to an oscillator circuit of the target system
Operating voltage	3.0 to 5.5 V	
Operating temperature	5 to 35°C (no dew)	
Storage temperature	-10 to 60°C (no dew)	
Power supply to emulator	12 V supplied from AC adapter	
Connection to target system (see "3.8 Connecting the Target System" on page 37)	<p>For 144-pin 0.5-mm-pitch LQFP (144P6Q-A): M3T-FLX-144NSD (not included)</p> <p>For 100-pin 0.5-mm-pitch LQFP (100P6Q-A): (1) M30800T-PTC (included) + M3T-100LCC-QSD (not included) (2) M30800T-PTC (included) + M3T-100LCC-DMS (not included) + M3T-FLX-100NSD (not included) (3) M3T-F160-100NSD (not included)</p> <p>For 100-pin 0.65-mm-pitch QFP (100P6S-A): (1) M30800T-PTC (included) + M3T-100LCC-DMS (not included) + M3T-FLX-100NRB (not included) (2) M30800T-PTC (included) + M3T-100LCC-DMS (not included) + M3T-DUMMY100S (not included) (3) M30800T-PTC (included) + M3T-100LCC-DMS (not included) + M3T-DIRECT100S (not included)</p> <p>For 100-pin LCC socket: M30800T-PTC (included) + IC61-1004-051 (included)</p>	

5.2 Connection Diagrams

Figures 5.1 and 5.2 show the connection diagrams of the M30850T-EPB. These connection diagrams mainly show the interface section. The signals not shown in Figures 5.1 and 5.2 are connected to the evaluation MCU in the emulation probe and the target system directly. The circuits not connected to the target system such as the emulator's control system are omitted.

Table 5.2 lists the electrical characteristics of the IC used for the user interface. Refer to it when using the emulator.

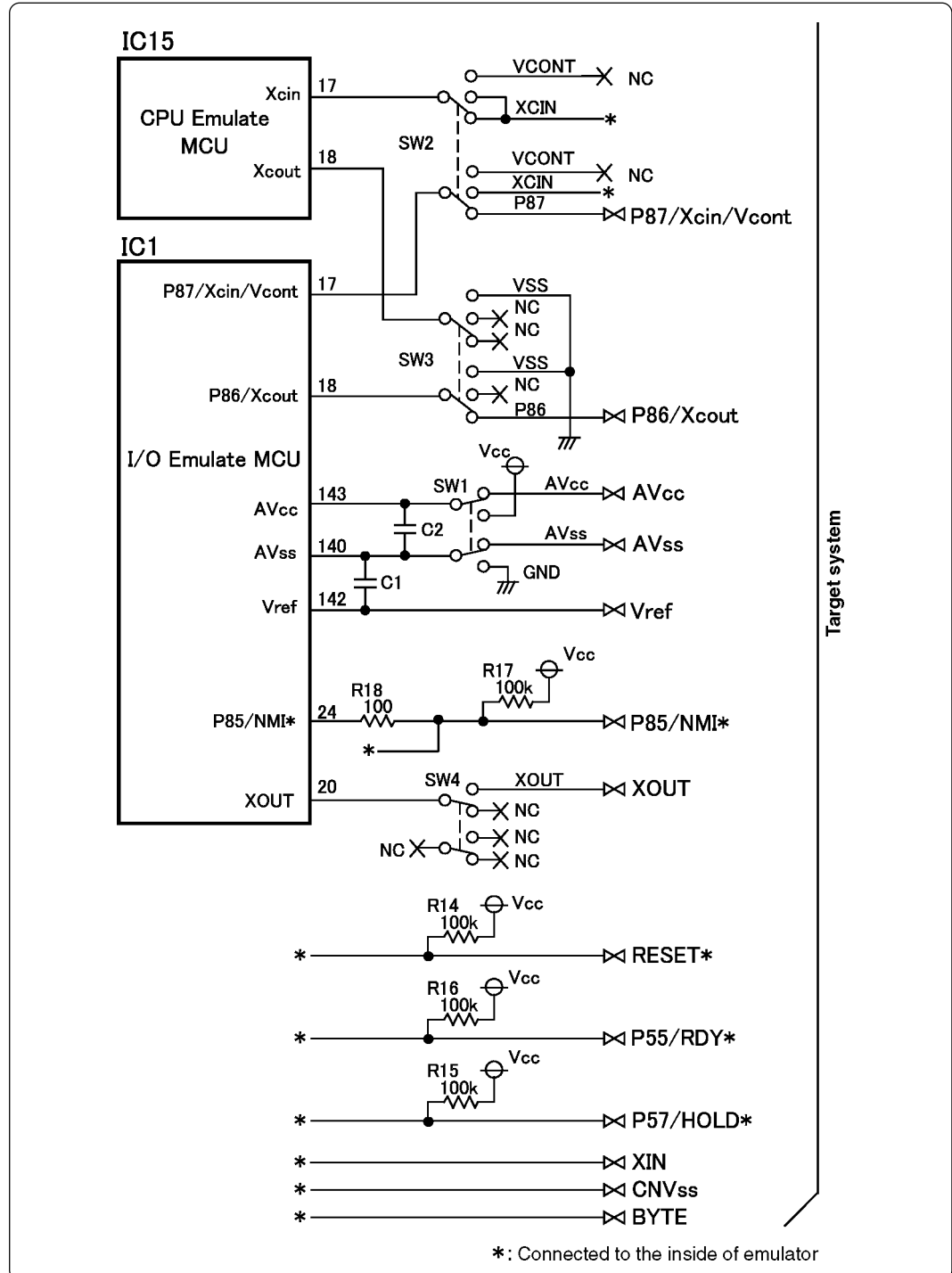

Figure 5.1 Connection diagram (1/2)

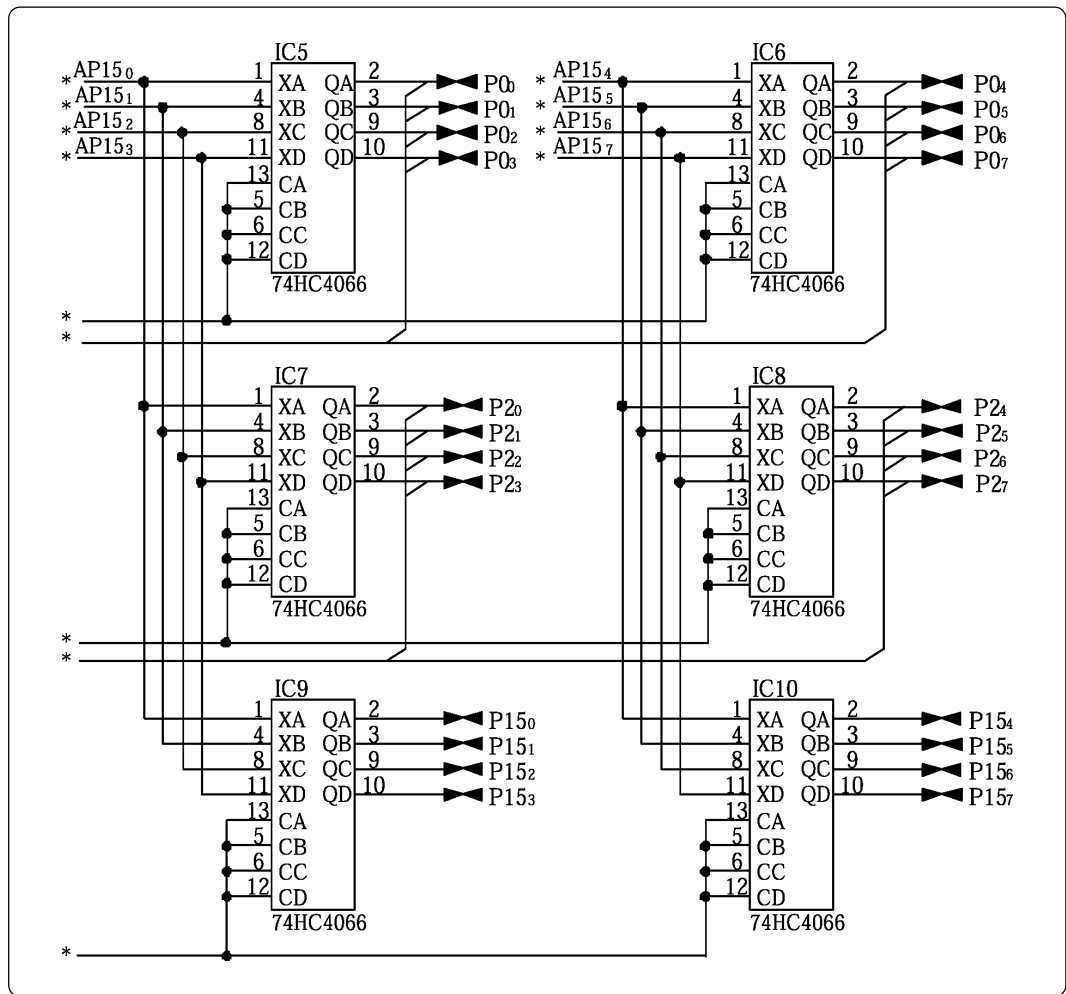

Figure 5.2 Connection diagram (2/2)

Table 5.2 Electrical characteristics of the 74HC4066

Symbol	Parameter	Measuring condition	Standard values			Unit
		Vcc	Min.	Standard	Max.	
R _{ON}	ON resistor	2.0	-	160	-	Ω
		4.5	-	70	100	
ΔR _{ON}	ON resistor difference	4.5	-	10	-	
I _{IN}	Switch input leak current	12.0	-	-	±100	nA

5.3 External Dimensions

(1) External Dimensions of the Emulation Probe

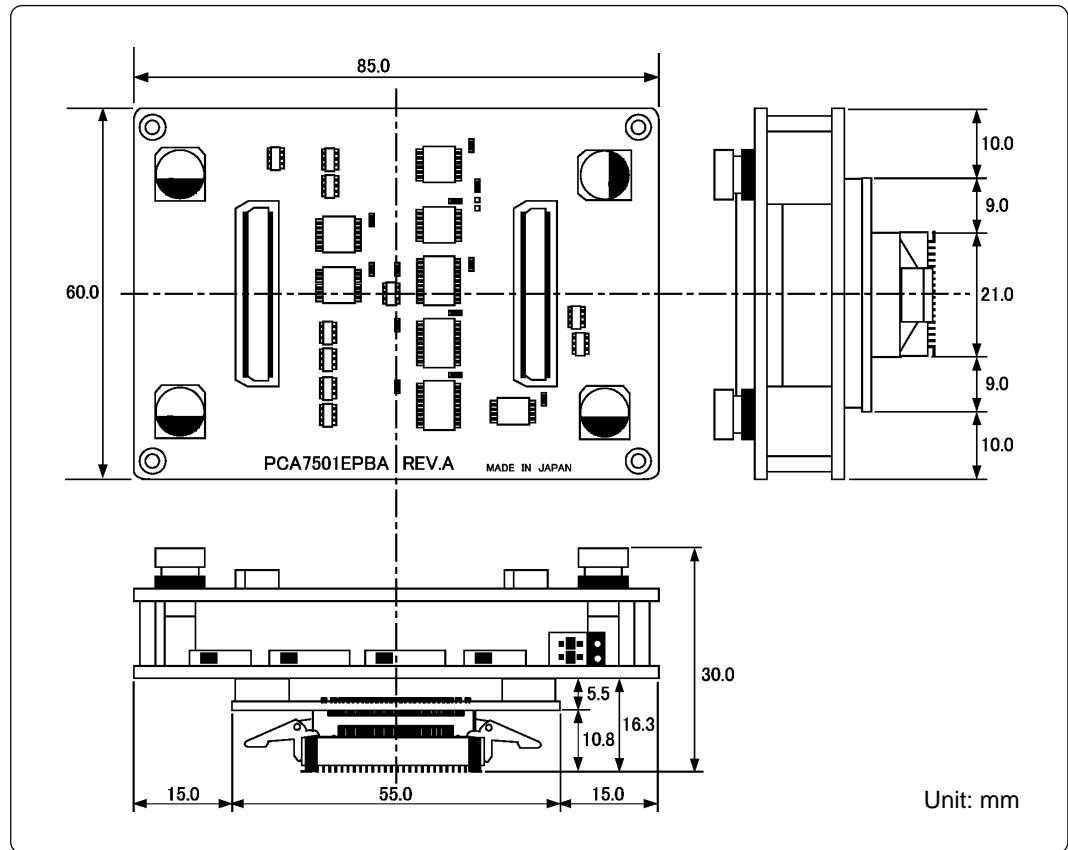

Figure 5.3 External dimensions of the emulation probe

(2) External Dimensions of Converter Board M30800T-PTC

Figure 5.4 shows the external dimensions of the pitch converter board M30800T-PTC for 100-pin QFP (100P6S).

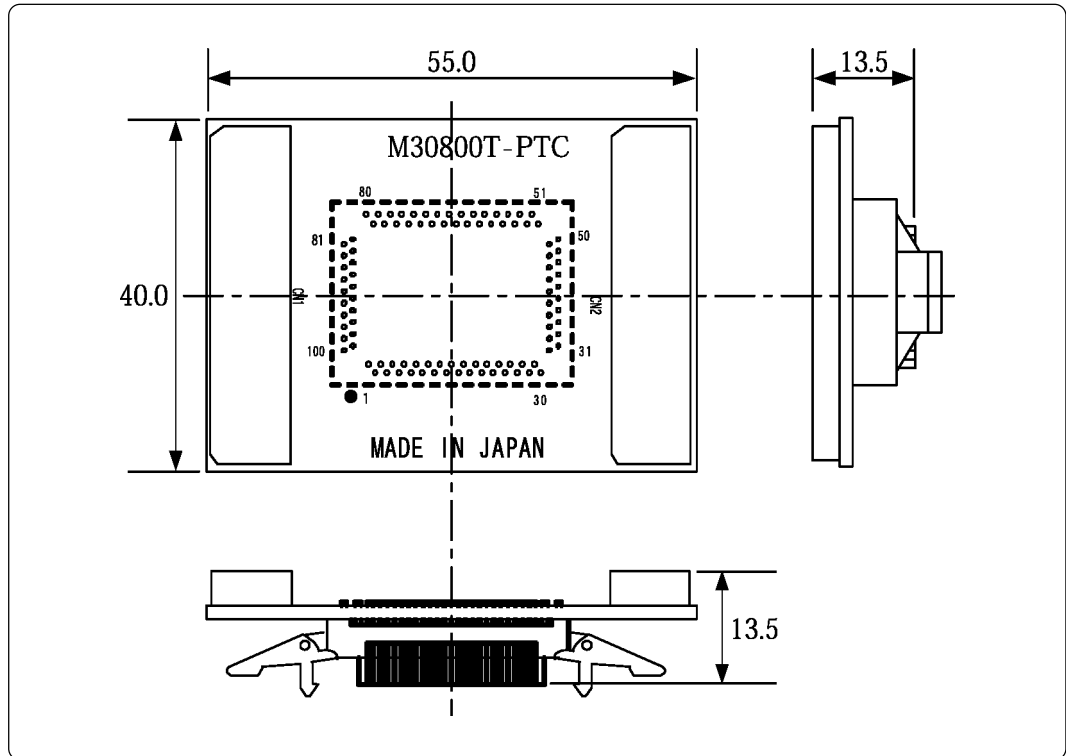

Figure 5.4 External dimensions of pitch converter board M30800T-PTC

(3) External Dimensions of Converter Board M3T-F160-100NSD

Figure 5.5 shows the external dimensions and the sample foot pattern of the converter board M3T-F160-100NSD for 100-pin LQFP (100P6Q).

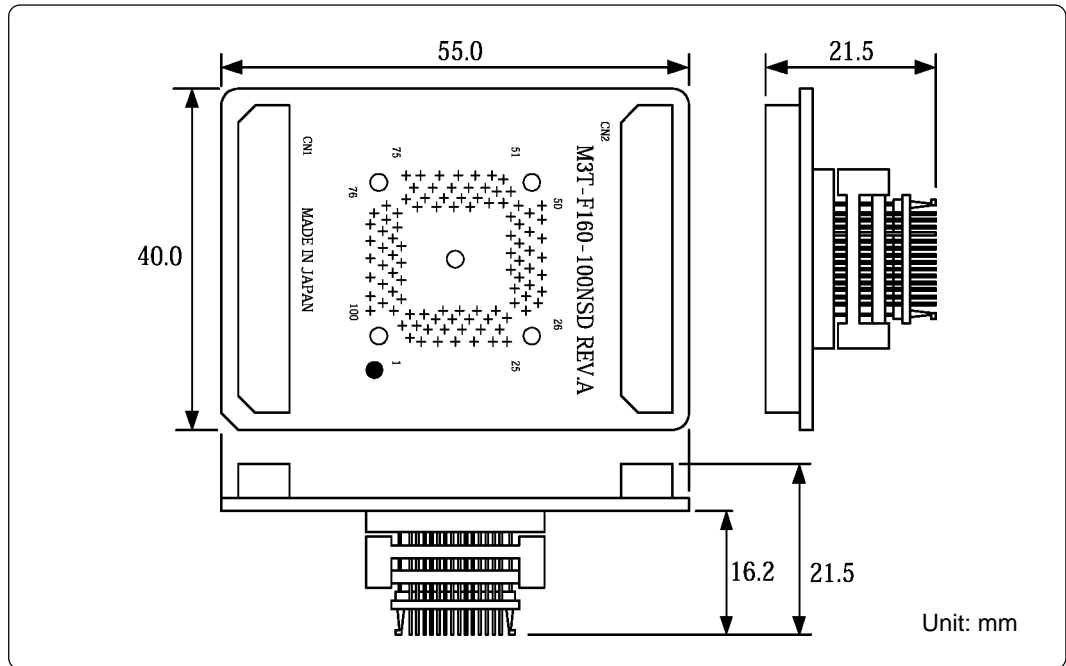

Figure 5.5 External dimensions of pitch converter board M3T-F160-100NSD

(4) External Dimensions of Converter Board M3T-FLX-144NSD

Figure 5.6 shows the external dimensions and the sample foot pattern of the pitch converter board M3T-FLX-144NSD for 144-pin LQFP (144P6Q).

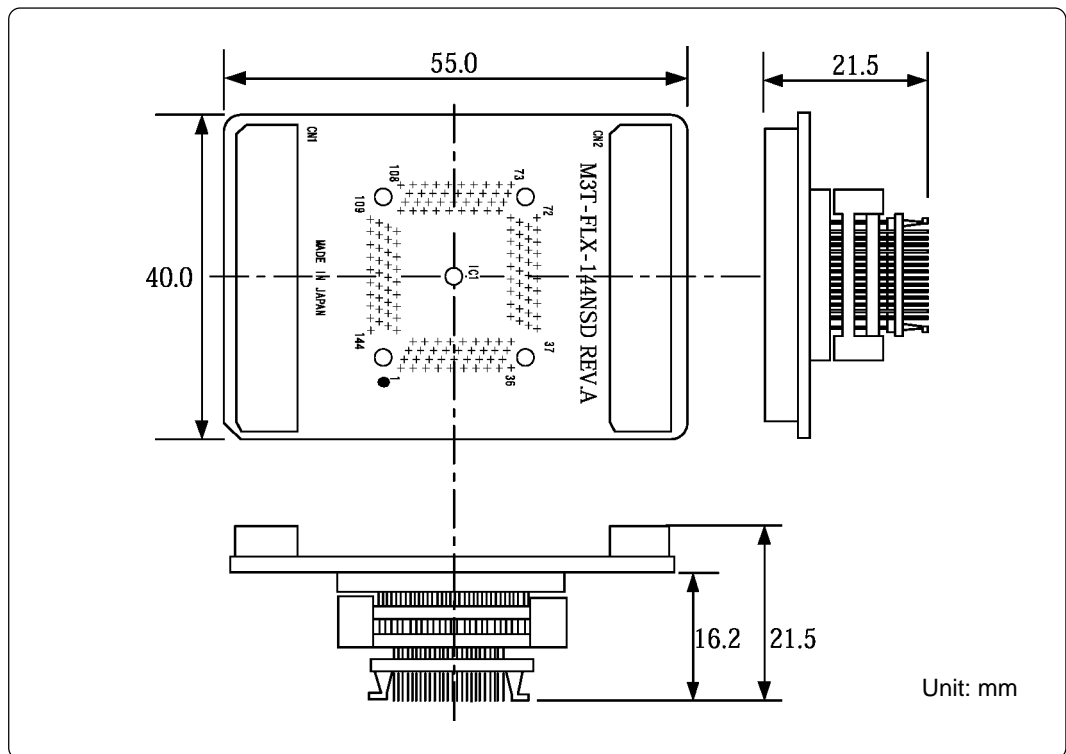

Figure 5.6 External dimensions of pitch converter board M3T-FLX-144NSD

MEMO

Chapter 6. Troubleshooting

This chapter describes how to troubleshoot when this product does not work properly.

6.1 Flowchart to Remedy the Troubles	66
6.2 When the Emulator Debugger Does Not Start Up Properly	67
(1) When the LED Display of the PC7501 is Abnormal	67
(2) EMEM Dialog Box is Not Displayed at Debugger Startup (Target Connected).....	68
(3) EMEM Dialog Box is Not Displayed at Debugger Startup (Target Not Connected).....	69
(4) Errors Occur at Debugger Startup (Target Connected)	69
6.3 How to Request for Support	70

Chapter 6. Troubleshooting

6.1 Flowchart to Remedy the Troubles

Figure 6.1 shows the flowchart to remedy the troubles from when power to the emulator is activated until the emulator debugger starts up. Check this while the target system is disconnected. For the latest FAQs visit the Renesas Tools Homepage.

http://www.renesas.com/eng/products/mpumcu/toolhp/faq/m16c80/m16c80_e.htm

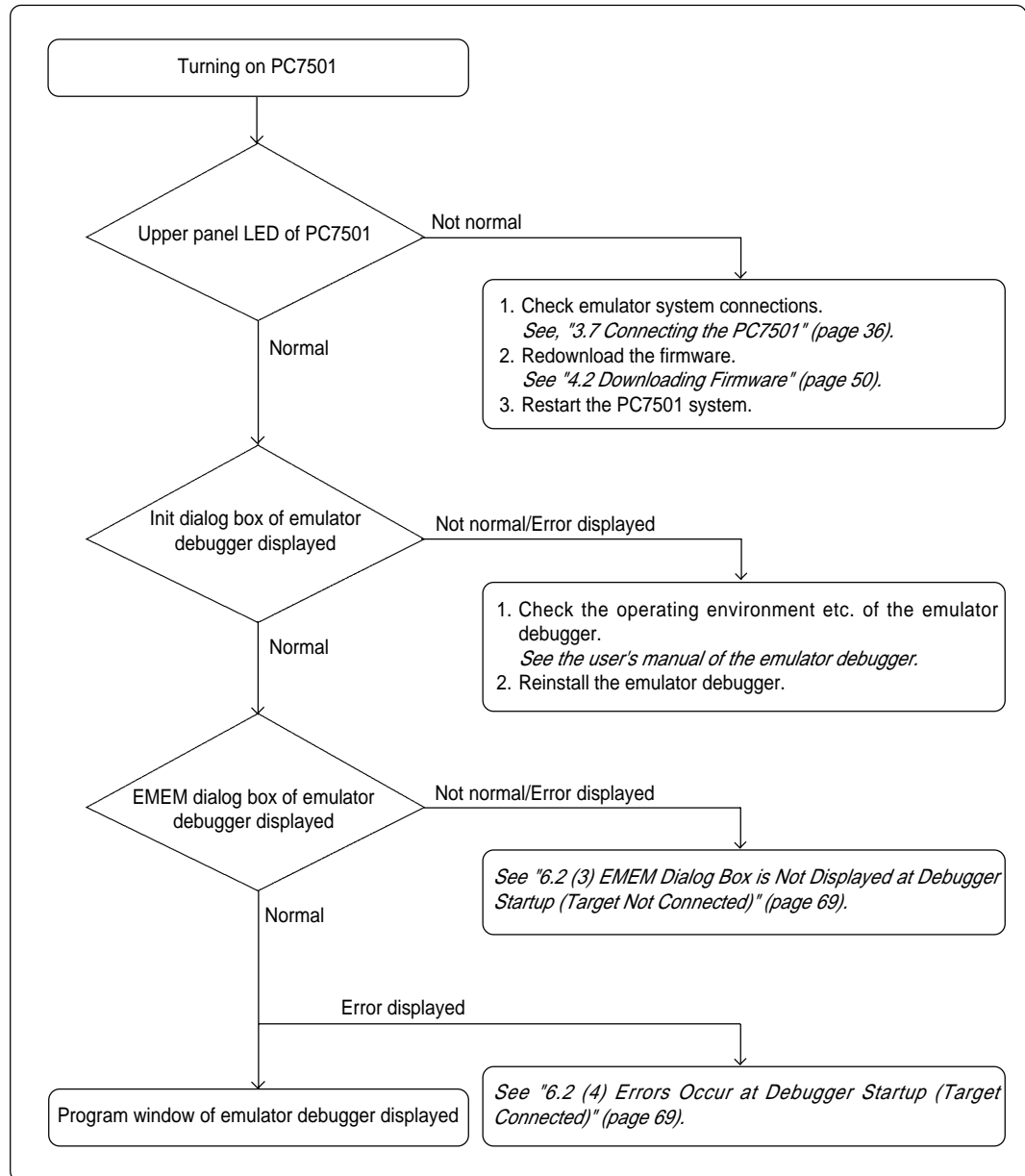

Figure 6.1 Flowchart to remedy the troubles

6.2 When the Emulator Debugger Does Not Start Up Properly

(1) When the LED Display of the PC7501 is Abnormal

Table 6.1 LED's abnormal display and its checkpoints

Error	Connection to the target system	Checkpoint
LEDs do not light up.	-	Recheck the power cable is connected to the PC7501. <i>See the user's manual of the PC7501.</i>
All LEDs remain lit.	-	Recheck the connection between the PC7501 and this product. <i>See "3.7 Connecting the PC7501" (page 36).</i>
The POWER LED of "STATUS OF TARGET" does not light up.	Connected	Check power is properly supplied to the target system and that the target system is properly grounded.
The CLOCK LED of "STATUS OF TARGET" does not light up.	Not connected	(1) Check that both the main and sub clocks of the emulator debugger are not set to "EXT". <i>See the CLK command of the emulator debugger.</i> (2) Check the oscillation circuit in the emulator is oscillating. <i>See "3.1 Selecting Clock Supply" (page 26).</i>
	Connected	(1) Check the oscillation circuit in the target system is oscillating. (2) Check the switches in the emulation probe are correctly set. <i>See "3.5 Setting Switches" (page 31).</i>
The RESET LED of "STATUS OF TARGET" does not go out.	Connected	Check the reset pin of the target system is pulled up.

(2) EMEM Dialog Box is Not Displayed at Debugger Startup (Target Connected)

Table 6.2 Checkpoints of errors when starting up the emulator debugger (target is connected)

Error	Checkpoint
Communication error occurred. Data was not sent to the target.	Check all emulator debugger settings, interface cable settings and switches on the rear of the PC7501 match. <i>See the user's manuals of the PC7501 and emulator debugger.</i>
Target system cannot be properly built.	(1) Download the proper firmware. <i>See "4.2 Downloading Firmware" (page 50).</i> (2) Recheck the connection between the PC7501 and this product. <i>See "3.7 Connecting the PC7501" (page 36).</i>
M3T-PD308F version is not the same version as the firmware in the target.	Download the proper firmware. <i>See "4.2 Downloading Firmware" (page 50).</i>
Target MCU is in the reset state.	(1) Check the reset pin of the target system is pulled up. (2) Check the reset pin of the target system has changed from "L" to "H" level.
Target MCU cannot be reset.	(1) Check pin NMI* is held high. (2) If in memory expansion mode or microprocessor mode, check pins RDY* and HOLD* are held high. (3) If the reset circuit of the target system has a watchdog timer, disable the timer. (4) Check that power is properly supplied to the target system and that the target system is properly grounded. (5) The program may be uncontrollable in areas where memory is not allocated. Recheck the map setting. <i>See "4.3 Starting Up the Emulator Debugger (Setting the EMEM Dialog Box)" (page 51).</i>
Target is in "HOLD" state.	(1) The MCU is either in stop mode or wait mode. Either reset the MCU or cancel the mode with an interrupt. <i>See MCU specifications.</i> (2) The program may be uncontrollable in areas where memory is not allocated. Recheck the map setting. <i>See "4.3 Starting Up the Emulator Debugger (Setting the EMEM Dialog Box)" (page 51).</i>
Target clock is stopped.	(1) Check the oscillation circuit of the target system is oscillating properly. (2) Check the switches in the emulation probe are correctly set. <i>See "3.5 Setting Switches" (page 31).</i>
Target MCU is not receiving power.	Check that power is properly supplied to the target system and that the target system is properly grounded.

(3) EMEM Dialog Box is Not Displayed at Debugger Startup (Target Not Connected)

Table 6.3 Checkpoints of errors when starting up the emulator debugger (target is not connected)

Error	Checkpoint
Communication error occurred. Data was not sent to the target.	Check all emulator debugger settings, interface cable settings and switches on the rear of the PC7501 match. <i>See the user's manuals of the PC7501 and emulator debugger.</i>
Target system cannot be properly built.	(1) Download the proper firmware. <i>See "4.2 Downloading Firmware" (page 50).</i> (2) Recheck the connection between the PC7501 and this product. <i>See "3.7 Connecting the PC7501" (page 36).</i>
M3T-PD308F version is not the same version as the firmware in the target.	Download the proper firmware. <i>See "4.2 Downloading Firmware" (page 50).</i>
Target MCU cannot be reset.	The program may be uncontrollable in areas where memory is not allocated. Recheck the map setting. <i>See "4.3 Starting Up the Emulator Debugger (Setting the EMEM Dialog Box)" (page 51).</i>
Target is in HOLD state.	(1) The MCU is either in stop mode or wait mode. Either reset the MCU or cancel the mode with an interrupt. <i>See MCU specifications.</i> (2) The program may be uncontrollable in areas where memory is not allocated. Recheck the map setting. <i>See "4.3 Starting Up the Emulator Debugger (Setting the EMEM Dialog Box)" (page 51).</i>
Target clock is stopped.	Check the switches in the emulation probe are correctly set. <i>See "3.5 Setting Switches" (page 31).</i>

(4) Errors Occur at Debugger Startup (Target Connected)

Table 6.4 Checkpoints of errors when starting up the emulator debugger (target is connected)

Error	Checkpoint
Target MCU is uncontrollable.	(1) Check pin NMI* is held high. (2) If in memory expansion mode or microprocessor mode, check pins RDY* and HOLD* are held high. (3) The program may be uncontrollable in areas where memory is not allocated. Recheck the map setting. <i>See "4.3 Starting Up the Emulator Debugger (Setting the EMEM Dialog Box)" (page 51).</i>

6.3 How to Request for Support

After checking the items in "Chapter 6 Troubleshooting", fill in the text file the installer of the emulator debugger generates in the following directory and email to your local distributor.

\\SUPPORT\product name\SUPPORT.TXT

For prompt response, please specify the following information:

(1) Operating environment

- Operating voltage: X.X [V]
- Operating frequency: XX.X [MHz]
- Clock supply to the MCU: Internal oscillator/External oscillator
- Target system: Connected/Not connected

(2) Condition

- The emulator debugger starts up/does not start up
- The error is detected/not detected in the self-check
- Frequency of errors: always/frequency ()

(3) Problem

Chapter 7. Maintenance and Guarantee

This chapter describes how to maintenance, repair provisions and how to request for repair.

7.1 Maintenance	72
7.2 Guarantee	72
7.3 Repair Provisions	72
7.4 How to Request for Repair	73

Chapter 7. Maintenance and Guarantee

7.1 Maintenance

If dust or dirt collects on any equipment of your emulation system, wipe it off with a dry soft cloth. Do not use thinner or other solvents because these chemicals can cause the equipment's surface coating to separate.

7.2 Guarantee

If your product becomes faulty within one year after its purchase while being used under good conditions by observing "Precautions for Safety" described in Chapter 1 of this user's manual, we will repair or replace your faulty product free of charge. Note, however, that if your product's fault is raised by any one of the following causes, we will repair it or replace it with new one with extra-charge:

- Misuse, abuse, or use under extraordinary conditions
- Unauthorized repair, remodeling, maintenance, and so on
- Inadequate user's system or misuse of it
- Fires, earthquakes, and other unexpected disasters

In the above cases, contact your local distributor. If your product is being leased, consult the leasing company or the owner.

7.3 Repair Provisions

(1) Repair with extra-charge

The products elapsed more than one year after purchase can be repaired with extra-charge.

(2) Replacement with extra-charge

If your product's fault falls in any of the following categories, the fault will be corrected by replacing the entire product instead of repair, or you will be advised to purchase new one, depending on the severity of the fault.

- Faulty or broken mechanical portions
- Flaw, separation, or rust in coated or plated portions
- Flaw or cracks in plastic portions
- Faults or breakage caused by improper use or unauthorized repair or modification
- Heavily damaged electric circuits due to overvoltage, overcurrent or shorting of power supply
- Cracks in the printed circuit board or burnt-down patterns
- Wide range of faults that makes replacement less expensive than repair
- Unlocatable or unidentified faults

(3) Expiration of the repair period

When a period of one year elapses after the model was dropped from production, repairing products of the model may become impossible.

(4) Transportation fees at sending your product for repair

Please send your product to us for repair at your expense.

7.4 How to Request for Repair

If your product is found faulty, follow the procedure below to send your product for repair.

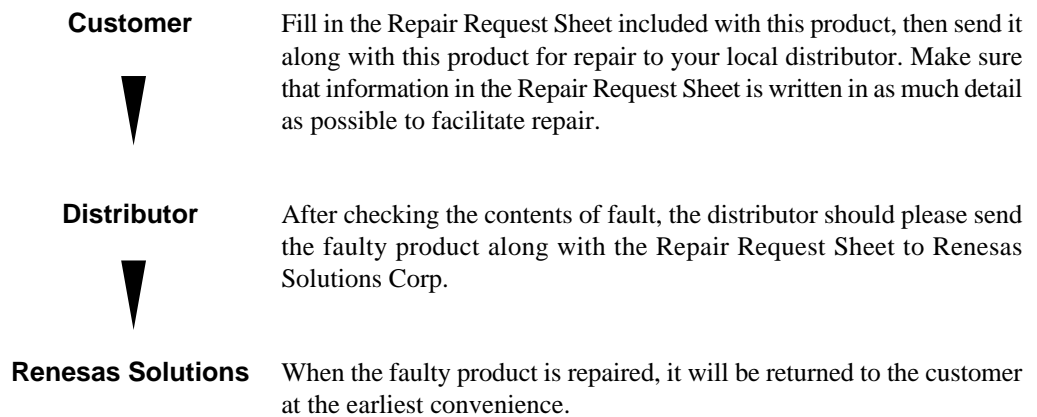

CAUTION

Note on Transporting the Product:



- When sending your product for repair, use the packing box and cushion material supplied with this product when delivered to you and specify handling caution for it to be handled as precision equipment. If packing of your product is not complete, it may be damaged during transportation. When you pack your product in a bag, make sure to use conductive polyvinyl supplied with this product (usually a blue bag). When you use other bags, they may cause a trouble on your product because of static electricity.

MEMO

M30850T-EPB User's Manual

Rev.2.00
April 1, 2004
REJ10J0345-0200Z

COPYRIGHT ©2003-2004 RENESAS TECHNOLOGY CORPORATION
AND RENESAS SOLUTIONS CORPORATION ALL RIGHTS RESERVED



RenesasTechnology Corp.

2-6-2, Ote-machi, Chiyoda-ku, Tokyo, 100-0004, Japan